



GP50 GRADIENT PUMP OPERATOR'S MANUAL

© 2001 Dionex Corporation

Document No. 031377
Revision 03
July 2001

©2001 by Dionex Corporation
All rights reserved worldwide.
Printed in the United States of America.

This publication is protected by federal copyright law. No part of this publication may be copied or distributed, transmitted, transcribed, stored in a retrieval system, or transmitted into any human or computer language, in any form or by any means, electronic, mechanical, magnetic, manual, or otherwise, or disclosed to third parties without the express written permission of Dionex Corporation, 1228 Titan Way, Sunnyvale, California 94088-3603 U.S.A.

DISCLAIMER OF WARRANTY AND LIMITED WARRANTY

THIS PUBLICATION IS PROVIDED “AS IS” WITHOUT WARRANTY OF ANY KIND. DIONEX CORPORATION DOES NOT WARRANT, GUARANTEE, OR MAKE ANY EXPRESS OR IMPLIED REPRESENTATIONS REGARDING THE USE, OR THE RESULTS OF THE USE, OF THIS PUBLICATION IN TERMS OF CORRECTNESS, ACCURACY, RELIABILITY, CURRENTNESS, OR OTHERWISE. FURTHER, DIONEX CORPORATION RESERVES THE RIGHT TO REVISE THIS PUBLICATION AND TO MAKE CHANGES FROM TIME TO TIME IN THE CONTENT HEREINOF WITHOUT OBLIGATION OF DIONEX CORPORATION TO NOTIFY ANY PERSON OR ORGANIZATION OF SUCH REVISION OR CHANGES.

TRADEMARKS

DX-LAN™ is a trademark, and PeakNet®, Self-Regenerating Suppressor®, and SRS® are registered trademarks of Dionex Corporation
Tefzel® is a registered trademark of E.I. duPont de Nemours & Co.

PRINTING HISTORY

Revision 01, May 1998
Revision 02, October 2000
Revision 03, July 2001

1 • Introduction

1.1	Overview	1-1
1.2	About This Manual	1-2
1.2.1	Safety Messages and Notes	1-3
1.2.2	Safety Labels	1-4

2 • Description

2.1	Front Control Panel	2-2
2.1.1	Control Panel Keypad	2-3
2.1.2	Display Screens	2-7
2.2	Electronics Chassis	2-8
2.3	Mechanical Chassis	2-11
2.4	Mechanical Components	2-12
2.4.1	Pump Eluent Manifold	2-13
2.4.2	Pump Heads	2-14
2.4.3	Pump Mixers	2-14
2.4.4	Pump Priming Block	2-15
2.4.5	Pressure Transducer	2-15
2.5	Vacuum Degas Pump Assembly (Optional)	2-16
2.6	Piston Seal Wash (Optional)	2-16
2.7	Eluent Reservoirs	2-17

2.8	Rear Panel	2-18
2.9	Functional Description	2-18
2.9.1	Operating and Control Modes	2-18
2.9.2	Local and Remote Modes	2-19
2.9.3	Method Control	2-20
2.9.4	Eluent Delivery	2-22

3 • Operation and Maintenance

3.1	Getting Ready to Run	3-1
3.1.1	Degas Eluents	3-1
3.1.2	Filter Eluents	3-2
3.1.3	Pressurize Eluent Reservoirs	3-2
3.1.4	Start-Up	3-3
3.1.5	Selecting the Pressure Limits	3-4
3.1.6	Selecting the Operating and Control Modes	3-5
3.2	Running Under Direct Control (Local Mode)	3-6
3.3	Running Under Method Control (Local Mode)	3-7
3.3.1	Creating a New Method	3-8
3.3.2	Running a Method	3-10
3.3.3	Editing a Method	3-11
3.3.4	Deleting a Method	3-12
3.3.5	Changing the Running Method	3-12
3.3.6	Controlling the Method Clock	3-12

3.4 Example Methods3-13

 3.4.1 Isocratic Method Example3-13

 3.4.2 Linear Gradient Method Example3-14

 3.4.3 Curved Gradient Method Example3-19

 3.4.4 Editing a Running Method Example3-23

3.5 Routine Maintenance3-25

 3.5.1 Daily Maintenance3-25

 3.5.2 Periodic Maintenance3-27

3.6 Shutdown3-27

4 • Troubleshooting

4.1 Left-Right Pump Head Pressure Fluctuations4-1

4.2 Pump Will Not Start4-3

4.3 Pump Stops4-3

4.4 Liquid Leaks/Leak Alarm4-7

4.5 Noisy Pump Motor4-8

4.6 Vacuum Degas Pump Does Not Run4-9

4.7 Vacuum Degas Pump Calibration Fails4-10

4.8 Vacuum Degas Pump Low Vacuum4-11

4.9 Relays or TTLs Inoperative4-11

4.10 Poor Chromatographic Reproducibility4-12

5 • Service

5.1	Cleaning and Replacing the Check Valves	5-1
5.2	Piston Seal Replacement	5-4
5.3	Pump Piston Replacement	5-8
5.4	Pressure Transducer Waste Valve O-Ring Replacement	5-10
5.5	Proportioning Valve Replacement	5-11
5.6	Changing Main Power Fuses	5-13

A • Specifications

A.1	Electrical	A-1
A.2	Environmental	A-1
A.3	Physical	A-1
A.4	Display and Keypad	A-1
A.5	Hydraulics	A-2
A.6	Control	A-3
A.7	Vacuum Degas Pump Assembly (Optional)	A-3

B • Installation

B.1	Facility Requirements	B-1
B.2	Installation Instructions	B-2
B.2.1	Power Connection	B-2
B.2.2	Electronics Chassis Connections	B-4
B.2.3	DX-LAN Interface: 10BASE-T Connections (Optional).	B-6

B.2.4 DX-LAN Interface: BNC Connections (Optional) B-9

B.2.5 Waste Lines B-13

B.2.6 Eluent Inlet Line Connections B-14

B.2.7 Eluent Outlet Line Connections B-14

B.2.8 Piston Seal Wash Connections (Optional) B-15

B.2.9 Priming the Pump B-17

B.3 Automatic SRS Power Control (Optional) B-20

C • Display Screens

C.1 Operational Screens C-2

 C.1.1 Menu of Screens C-2

 C.1.2 Main Screen C-3

 C.1.3 Detail Screen C-5

 C.1.4 Method Screen C-6

 C.1.5 Method Extension Screen C-8

 C.1.6 Degas Options C-9

 C.1.7 Module Setup C-11

 C.1.8 Pump Options C-12

 C.1.9 Time Function In C-13

C.2 Diagnostic Screens C-14

 C.2.1 Diagnostic Menu C-14

 C.2.2 Power-Up Screen C-15

 C.2.3 Elapsed Time C-16

 C.2.4 DSP Status C-17

C.2.5	DX-LAN Status	C-18
C.2.6	Keyboard Test	C-20
C.2.7	Diagnostic Test.	C-21
C.2.8	Pressure Statistics.	C-23
C.2.9	DSP Code Version	C-24
C.3	Calibration Screens	C-25
C.3.1	Calibration Menu	C-25
C.3.2	Calibration Status	C-26
C.3.3	Leak Sensor Calibration and Status	C-27
C.3.4	Degas Status	C-28
C.3.5	Flow Calibration.	C-29
C.3.6	Pressure Calibration	C-30
C.3.7	Degas Pump Calibration.	C-34

D • TTL and Relay Control

D.1	TTL and Relay Output Operation	D-2
D.2	TTL Input Operation	D-3
D.2.1	TTL Input Signal Modes	D-3
D.3	TTL and Relay Connections	D-5
D.3.1	Example Connections.	D-6

1.1 Overview

The GP50 Gradient Pump is an integral part of a Dionex chromatography system. It is a microprocessor-based, dual-piston, variable-speed, gradient delivery system designed to blend and pump mixtures of up to four different eluents at precisely controlled flow rates. The pump can deliver the selected eluent composition isocratically, or as a multistep linear or curved gradient. A Digital Signal Processor (DSP) provides high speed control of pump flow and pressure.

The pump can operate as a stand-alone product or with other Dionex modules as part of a complete chromatography system. It can also be used with non-Dionex modules that meet interface requirements for software, TTL, or relay control.

The GP50 can be controlled locally, using the front panel keypad and display, or from a remote host computer with a Dionex DX-LAN™ interface installed and PeakNet® software installed on the host computer. Limited remote control is also available from any device capable of providing compatible TTL signals to control the pump.

The pump's two basic modes of control, Direct control and Method control, enable it to operate with or without reference to time-based events.

The GP50 is available in four versions. An optional vacuum degas pump is available for all versions:

GP50 Gradient Pump Version	With Degas Pump	Without Degas Pump
Standard bore with PEEK components	P/N 054426	P/N 054427
Standard bore with stainless steel components	P/N 054419	P/N 054420
Microbore with PEEK components	P/N 054045	P/N 054429
Microbore with stainless steel components	P/N 054425	P/N 054424

1.2 About This Manual

Chapter 1 Introduction	Gives an overview of the GP50 Gradient Pump, and explains conventions used in this manual, including safety-related information.
Chapter 2 Description	Describes the GP50 front panel controls, electronic and mechanical components, and operating modes.
Chapter 3 Operation and Maintenance	Provides an overview of GP50 operation, including how to create, edit, and run methods from the GP50 front panel. Lists routine preventive maintenance procedures.
Chapter 4 Troubleshooting	Lists problems and presents step-by-step procedures for how to isolate and eliminate them.
Chapter 5 Service	Provides step-by-step instructions for routine service and parts replacement procedures.
Appendix A Specifications	Lists the GP50 specifications and installation site requirements.
Appendix B Installation	Describes how to install the GP50.
Appendix C Display Screens	Illustrates and describes all of the screens that can be displayed on the GP50 front panel.
Appendix D TTL and Relay Control	Describes relay and TTL input and output functions and provides installation instructions.

1.2.1 Safety Messages and Notes

This manual contains warnings and precautionary statements that, when properly followed, can prevent personal injury and/or damage to the GP50. Safety messages appear in bold type and are accompanied by icons, as shown below.



Indicates an imminently hazardous situation which, if not avoided, will result in death or serious injury.



Indicates a potentially hazardous situation which, if not avoided, could result in death or serious injury.



Indicates a potentially hazardous situation which, if not avoided, may result in minor or moderate injury.



Indicates that the function or process of the instrument may be impaired. Operation does not constitute a hazard.

Informational messages also appear throughout this manual. These are labeled NOTE and are in bold type:

NOTE NOTES call attention to certain information. They alert you to an unexpected result of an action, suggest how to optimize instrument performance, etc.

1.2.2 Safety Labels

The TUV GS, C, US Mark safety label and the CE Mark label on the GP50 indicate that the GP50 is in compliance with the following standards: EN 61010-1:1993 (safety), CAN/CSA-C22.2 No. 1010.1-92 (safety), UL 3101-1/10.93 (safety), EN 50082-1:1992 (susceptibility), and EN 55011:1991 (emissions).

The symbols below appear on the GP50, or on GP50 labels.



Alternating current



Protective conductor terminal



Power supply is on



Power supply is off

2 • Description

The GP50 Gradient Pump consists of two units (see Figure 2-1). The upper unit houses the electronics components and the lower unit houses the pump heads and other mechanical pump assemblies.

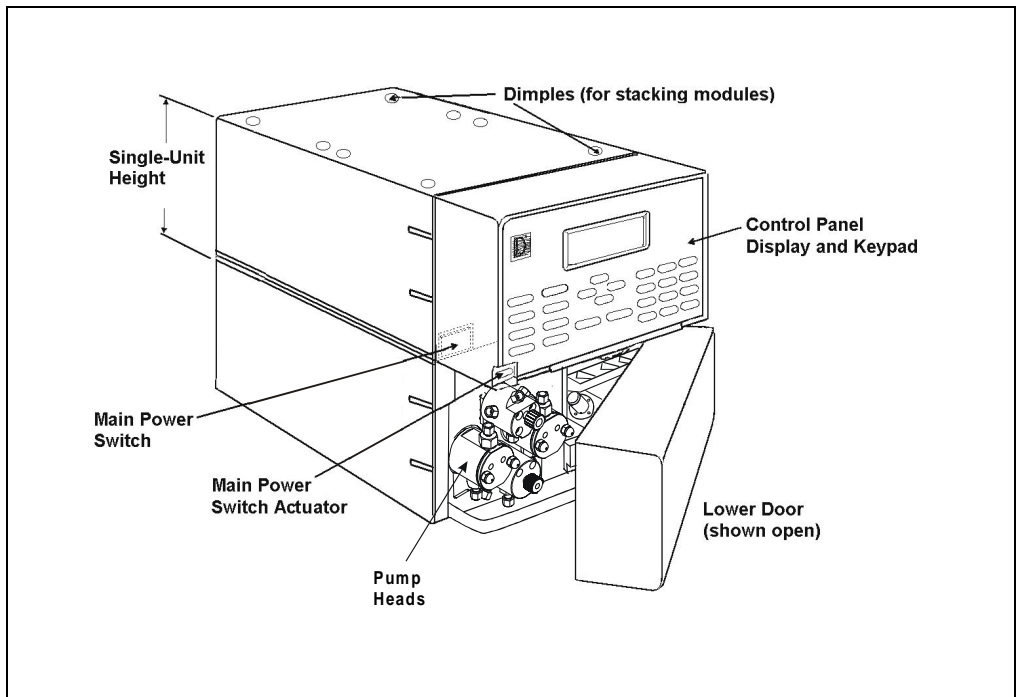

Figure 2-1. GP50 Enclosure

2.1 Front Control Panel

The control panel on the upper door of the pump enclosure contains a liquid crystal display (LCD), a membrane keypad, and the actuator for the main power switch (see Figure 2-2). The door opens to provide access to the electronics chassis (see Section 2.2).

NOTE If no keypad buttons are pressed within a two-hour period, the front panel backlight will automatically turn off. To restore the backlight, press any button.

Screen Contrast

Information is displayed on the LCD, also called the *screen*. To adjust the screen contrast, use the knurled knob in the recess below the keypad (see Figure 2-2).

Tilt Panel

To maximize visibility, the front control panel can be tilted to four different positions. To tilt the panel, support the door at the left side (to prevent it from opening) and lift firmly on the tab in the middle of the recess below the keypad (see Figure 2-2). Push on the tab to return the panel to its vertical position.

Power Switches

The main power switch is on the bulkhead behind the upper door (see Figure 2-1). An actuator for the main power switch is on the outside of the front door, at the lower left corner (see Figure 2-2).

The actuator functions only when the door is fully closed. When the door is open, press the main power switch on the bulkhead to turn the module off and on.



To prevent damage to the pump circuitry and components, always wait at least 15 seconds after powering down before turning on the power again.

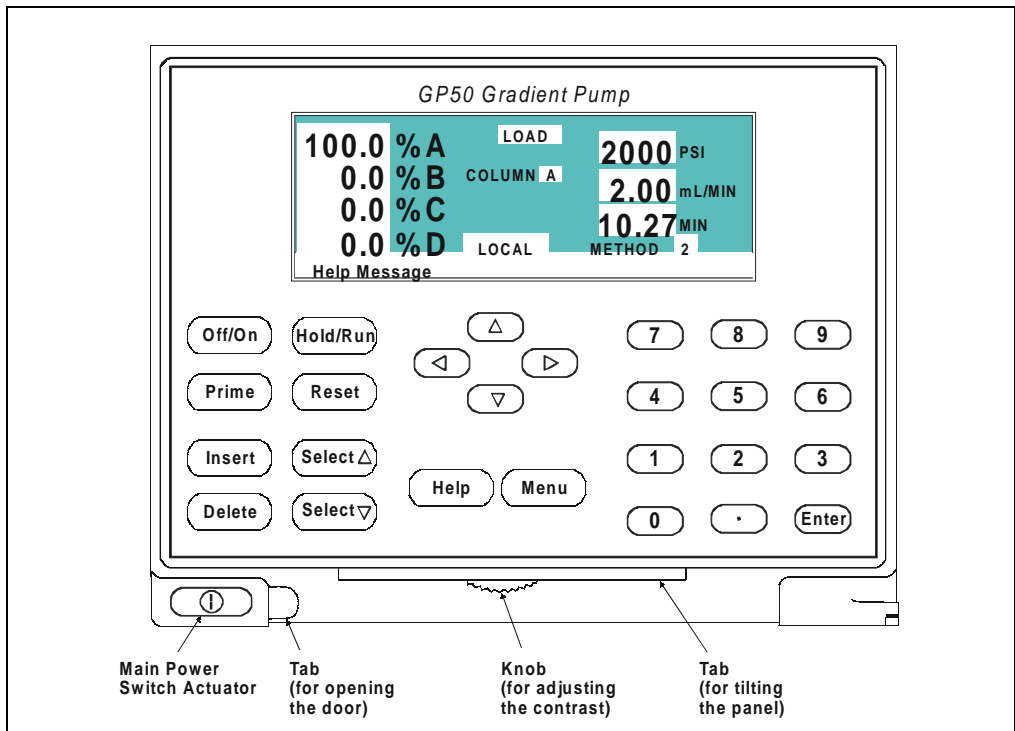

Figure 2-2. GP50 Display and Keypad Layout

2.1.1 Control Panel Keypad

Use the keypad to directly control pump operation, as well as to create and modify programmed series of timed events, called *methods*. In summary:

- Press **Menu** to display a list of available screens.
- To go from a menu to a screen, press the numeric button that corresponds to the screen's number on the menu, or move the cursor to the desired screen name and press **Enter**.
- Only fields shown in reverse video on a screen can be edited. Other fields display information only.
- To edit a value in a reverse video field, use the four directional arrow buttons to move the cursor to the field. Use the numeric buttons to

enter variable values, or use the **Select** Δ and **Select** ∇ buttons to choose from among predetermined options.

- To confirm the selected value, press **Enter** or an arrow button. In some screens or screen fields, pressing **Enter** is required.

NOTE A high-pitched beep sounds when you press a button. When an error occurs, this beep is lower in frequency. The beeps can be disabled from the **MODULE SET-UP** screen (see Section C.1.7).



Keypad Buttons	Function
	Turns the pump motor off and on. In Direct control (see Section 2.9), turning on the motor causes it to pump isocratically using the displayed eluent percentages and flow rate. In Method control (see Section 2.9.3), turning on the motor causes it to pump at the eluent percentages and flow rate for the elapsed time of the selected method, or at the initial conditions (when the method clock is at INIT).
	This button is used when priming the pump heads. Prime causes the pump to run at maximum volume (2.5 mL/min, microbore; 10.0 mL/min, standard bore). If the pump motor is off when Prime is pressed, the pump automatically turns on. To exit priming and return to the normal flow rate, press Prime again or press Off/On to turn off the pump motor. See Section B.2.8 for detailed priming instructions.
	Inserts a new step into a method. This button functions only when the cursor is in a TIME field on the METHOD or METHOD extension screen. <ol style="list-style-type: none">1. Move the cursor to the TIME field and press Insert. The new step is added below the cursor position. Parameter values in the new step are blank.2. Fill in the time value and press Enter or a cursor arrow button. Note: If you move the cursor out of the TIME field before entering a time value, the inserted step is not saved because it is incomplete.3. Insert steps in any order. When you press Enter, they will be automatically reorganized in the correct chronological order.

Table 2-1. GP50 Front Panel Buttons

Keypad Buttons	Function
Delete	<p>Removes the value from the current entry field. To restore the previous value, move the cursor from the field before entering a new value.</p> <p>Pressing Delete when the cursor is in a step entry field on the METHOD screen “blanks” the step parameter value. Moving the cursor to another field does not restore the previous value; instead, the step remains blank, indicating no change from the previous step.</p> <p>To delete an entire method step:</p> <ol style="list-style-type: none"> 1. Position the cursor in the method’s time field and press Delete. The time is removed and the help line prompts you to press Delete again to delete the step. 2. Press Delete again. Or, to restore the original time and step parameters, press any button except Delete.
Hold/Run	<p>Turns the method clock off (Hold) and on (Run). This button functions only when the pump is under Method control (see Section 2.9.3).</p> <p>When the method clock is in Hold, pressing Hold/Run starts the clock at either the initial step of a new method or, if resuming an interrupted method, at the time at which the clock was put in Hold.</p> <p>When the method clock is in Run, pressing Hold/Run stops the clock; this “holds” the method and freezes the current conditions.</p>
Reset	<p>Changes the method clock time to INIT, causing the initial conditions specified by the method to occur. This button functions only when the GP50 is under Method control (see Section 2.9.3).</p> <p>If the method is running, it continues running. If the method is in Hold, the method clock executes the initial conditions and holds.</p>
Select Δ	<p>When the cursor is positioned at a field with predetermined parameters, these buttons cycle through the options. In fields with predetermined numeric values, pressing Select Δ increases the value by one unit; pressing Select ∇ decreases the value by one unit. Holding down a Select button increases (or decreases) the value continuously. Press Enter or a cursor arrow button to confirm the selected value.</p>
Select ∇	

Table 2-1. GP50 Front Panel Buttons (Continued)







Keypad Buttons	Function
	<p>The four cursor buttons move the cursor, in the direction of the arrow, to the next entry field. If there is no changeable field in that direction, the cursor moves diagonally or remains in its current location.</p> <p>In most cases, after entering a new value in an entry field, pressing an arrow button saves and/or executes the change. The exceptions are the METHOD SAVE TO field, the METHOD RUN field, any calibration command, the DIAGNOSTIC TESTS screen, and all menu screens.</p>
	<p>Displays a help screen with information pertaining to the current entry field.</p>
	<p>Displays one of three menus, depending on the current screen:</p> <ul style="list-style-type: none"> • From an operational screen, pressing Menu displays the MENU of SCREENS. • From a diagnostic screen, pressing Menu displays the DIAGNOSTIC MENU. • From a calibration screen, pressing Menu displays the CALIBRATION MENU.
	<p>Enters numeric values into the current entry field. The numeric buttons are 0 through 9 and the decimal.</p>
	<p>From a menu screen, pressing a numeric button opens the corresponding screen.</p>
	<p>Saves and/or executes changes made in entry fields. If a menu screen is displayed, pressing Enter opens the highlighted screen.</p>

Table 2-1. GP50 Front Panel Buttons (Continued)

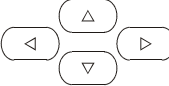
2.1.2 Display Screens

When the pump has successfully powered-up and passed all diagnostic tests, the **POWER-UP** screen (see Figure 2-3) displays briefly, followed by the **MAIN** screen (see Figure 2-4). If one of the diagnostic tests fails at power-up, the **DIAGNOSTIC TEST** screen displays instead of the **MAIN** screen. See Section C.2.7 if this occurs.

NOTE The **POWER-UP** screen can be viewed at any time by selecting the screen from the **DIAGNOSTIC MENU** (see Section C.2.1).

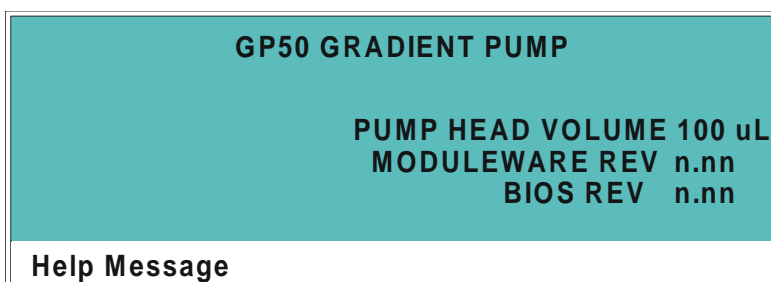

Figure 2-3. Power-Up Screen

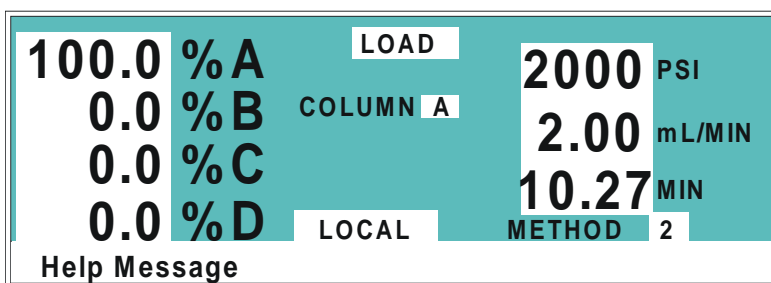

Figure 2-4. Main Screen

The **MAIN** screen displays status information in enlarged characters to allow viewing from a distance. Use the **MAIN** screen to select operating parameters, such as the flow rate and the percentages of eluents to run.

To access other GP50 screens, press the **Menu** button to display the **MENU of SCREENS** (see Figure 2-5).

There are two ways to select a screen from a menu:

- Press the numeric button on the front panel keypad that corresponds to the screen number on the menu. For example, press 3 to display the **METHOD** screen.
- Move the cursor to the field containing the screen number and press **Enter**.

See Appendix C for a description of each screen.

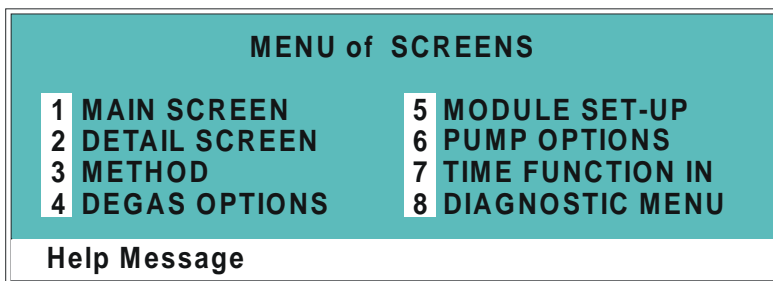

Figure 2-5. Menu of Screens

2.2 Electronics Chassis

The electronics chassis is located behind the upper door of the pump enclosure. The chassis includes several electronics cards (printed circuit boards) that are used to control the pump. Connectors on the cards also allow communication between the pump and other Dionex chromatography modules. Figure 2-6 shows the electronics components with the upper door open. To open the door, pull on the tab located to the right of the main power actuator (see Figure 2-2).



Do not remove any of the electronics cards from the pump. There are no user-serviceable components on the cards. If servicing is required, it must be performed by qualified personnel and appropriate electrostatic discharge (ESD) handling procedures must be followed.



Ne retirez aucune des cartes électroniques de la pompe. Aucun des composants sur les cartes ne peut être réparé par l'utilisateur. Toute réparation doit être effectuée par un personnel qualifié utilisant des procédures correctes de décharge électrostatique.

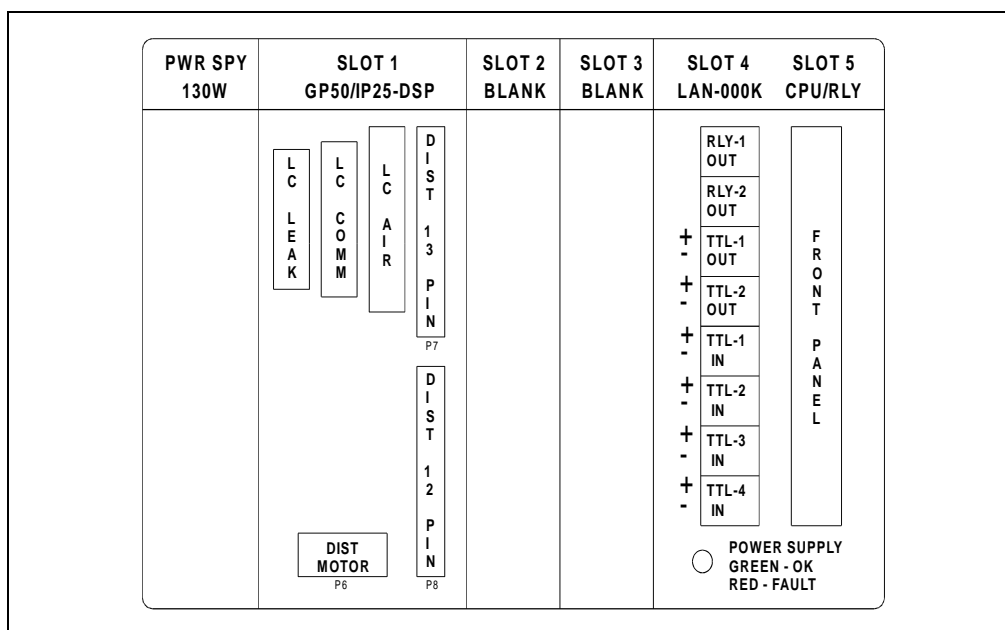

Figure 2-6. GP50 Electronics Chassis
(Located behind pump door)

LC LEAK

The leak control cable from the LC10 Chromatography Organizer or LC20 Chromatography Enclosure, connects to the **LC LEAK** connector in slot 1. When a leak occurs in the LC10 or LC20 it is reported to the GP50.

NOTE The **LC25 Chromatography Oven** and **LC30 Chromatography Oven** do not connect to the GP50 **LC LEAK** connector. These ovens contain internal leak control electronics.

LC COMM

The LC30 Chromatography Oven's RJ-11 serial cable connects to the **LC COMM** connector in slot 1. When connected, the LC30 can be remotely controlled by the PeakNet workstation.

LC AIR

The cable from the air solenoid valves in the LC10, LC20, LC25, or LC30 chromatography module connects to the **LC AIR** connector in slot 1. When connected, the GP50 can electrically actuate the solenoid valves that control the position of the injection valve and the optional column switching valve in the chromatography module.

To select the valve positions, go to either the **MAIN** screen (see Section C.1.2) or the **METHOD** screen (see Section C.1.4).

TTL/RELAY

A strip of eight relay and TTL connectors is located in slot 4. These connectors interface with Dionex and non-Dionex modules for relay and TTL control of the pump. Appendix D describes the relay and TTL functions and the connections between the GP50 and other modules.

CPU

Control Moduleware for the pump resides on the CPU/Relay cards.

The CPU logic and Relay I/O cards occupy slot 5. The Relay I/O card rides piggyback on the CPU card and extends over the front of slot 4. The card is short enough to allow the optional DX-LAN pump interface card (P/N 044195) to mount behind it in slot 4. A 60-pin ribbon cable links the CPU logic to the display and keypad. The logic monitors the internal power supply outputs, and reports the status on the multicolored LED at the bottom of slot 4.

- Green indicates normal operation.
- Red indicates a power fault. The GP50 will enter its diagnostic state and inhibit all other controls until the fault is corrected. If this occurs, turn off the power for a few seconds and then turn it back on.

2.3 Mechanical Chassis

The mechanical chassis is housed in a pull-out drawer located behind the lower door of the pump enclosure. The front of the chassis contains the components described in Section 2.4. Other mechanical assemblies are located inside the chassis drawer. The drawer should be pulled out only for service procedures. For routine operation, push in the drawer and tighten the lock located on the lower right corner of the chassis.



Observe the warning label on the inside of the lower door. The arrows on the label indicate moving mechanical parts that present pinch hazards when the pump is on and the mechanical drawer is open. Do not operate the pump with the mechanical chassis drawer pulled out.



Respectez l'étiquette d'avertissement apposée à l'intérieur de la porte inférieure. Les flèches sur l'étiquette indiquent des pièces mécaniques mobiles qui posent un danger de pincement lorsque le GP50 est sous tension et le tiroir mécanique est ouvert. N'utilisez jamais le GP50 avec le tiroir du châssis mécanique ouvert.

2.4 Mechanical Components

Figure 2-7 shows the mechanical components located behind the lower door of the enclosure.

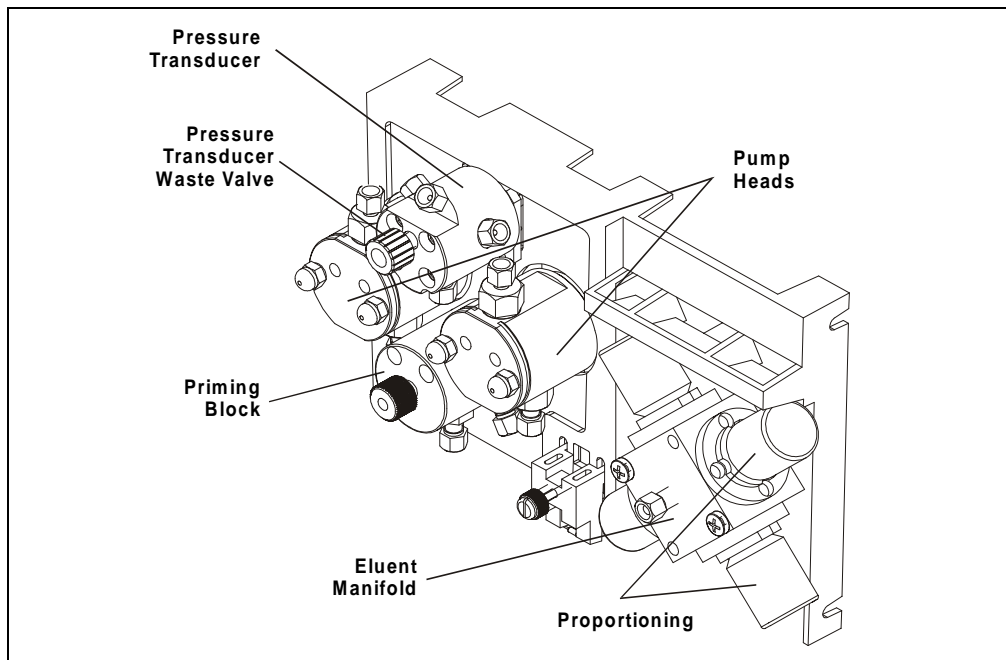

Figure 2-7. GP50 Mechanical Components

2.4.1 Pump Eluent Manifold

Eluent lines A through D are routed through the rear of the GP50 to the vacuum degas pump (if installed) (see Section 2.5) and then to the rear of the proportioning valve. If the vacuum degas pump is not installed, the eluent lines are connected directly to the proportioning valve. The proper proportion of eluent exits the front of the valve and is directed to the priming block. Figure 2-8 shows the eluent flow path through the system.

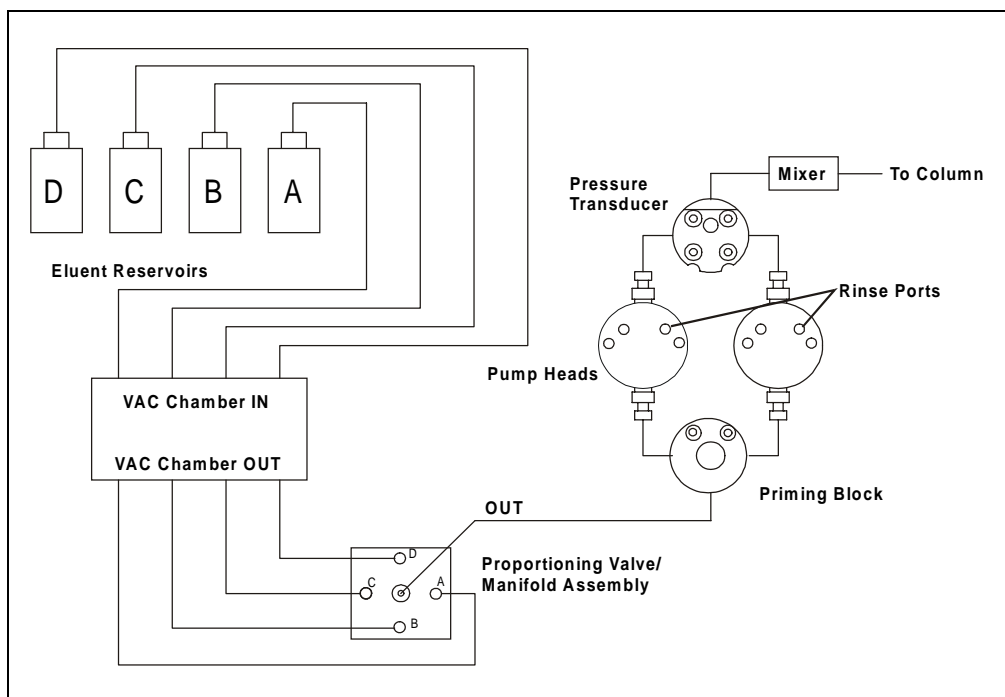

Figure 2-8. Eluent Flow Schematic

2.4.2 Pump Heads

There are two types of pump heads: standard bore and microbore. The table below summarizes the features and operating conditions for each type.

Pump Head Type	Piston Volume	Pump Operation	Flow Rate (mL/min)*	Maximum Operating Pressure
Standard Bore	100 μ L	Isocratic	0.04–10.0	35 MPa (5000 psi)
		Gradient	0.4–10.0	35 MPa (5000 psi)
Microbore	25 μ L	Isocratic and Gradient	0.0–2.50	35 MPa (5000 psi)

*Flow rates are adjustable in increments of 0.01 mL/min.

NOTE Although there is some overlap in flow rates between the two pump configurations, continuous operation of the microbore pump at flow rates above 2.0 mL/min will decrease seal and pump life. For the best extended operation at 2.0 mL/min or above, use a standard bore pump. To achieve optimum performance at flow rates below 0.4 mL/min, use a microbore pump.

2.4.3 Pump Mixers

A pump mixer ensures complete mixing of the proportioned eluents prior to injection. The mixer is installed between the pump outlet and the injection valve. Three types of mixers are available:

- In standard bore PEEK pumps, a GM-5 Mixer (P/N 054044) is used.
- In microbore PEEK pumps, a GM-4 Mixer (P/N 049136) is used.
- In stainless steel pumps, a Stainless Steel Mixer (P/N 054043) is used.

2.4.4 Pump Priming Block

The priming block “tee” directs the flow of eluent from the manifold into the pump heads. The priming block is also used for rapid removal of air from the system.

Refer to Section B.2.8 for instructions on priming the pump heads.

2.4.5 Pressure Transducer

From the priming block, the liquid stream is directed to the inlet check valves on the pump heads, through the pump heads, and finally through the outlet check valves to the pressure transducer.

Flow from the outlet check valves on the pump heads is combined in the pressure transducer. The pressure transducer measures the system pressure at this point. The interactive constant-flow/constant-pressure control program on the DSP precisely controls the pump motor speed to assure flow rate accuracy.

A waste line exits the bottom of the pressure transducer. Opening the valve on the pressure transducer diverts flow to the waste line and relieves system pressure, forcing air out of the system.

Flow output from the pressure transducer is directed out of the pump module, through the gradient mixer, and on to the rest of the chromatography system (injection valve, column, detector).

See Section B.2.6 for eluent outlet line connections.

2.5 Vacuum Degas Pump Assembly (Optional)

The Dionex vacuum degas pump provides continuous on-line vacuum degassing of up to four eluents. The assembly, which must be installed at the factory, consists of:

- A 4-channel degas chamber (with degas membranes) with 17 mL internal capacity per channel
- A dual-stage diaphragm vacuum pump
- A solenoid valve
- An on-board vacuum sensor
- The electronics required to operate the vacuum pump
- Fittings, tubing, and other accessories

By default, the degas pump turns on for 2 minutes when the GP50 power is turned on. Thereafter, the pump turns on for 30 seconds at 10-minute intervals. The **DEGAS OPTIONS** screen allows you to change the cycle time and duration (see Section C.1.6). You can check the vacuum chamber pressure from the **DEGAS STATUS** screen (see Section C.3.4).

NOTE All components of the vacuum degas assembly are made of inert materials or corrosion-resistant materials. However, Dionex recommends thoroughly flushing any chemicals out of the tubing with deionized water after each use to avoid crystallization in the membrane pores.

2.6 Piston Seal Wash (Optional)

When using highly concentrated buffer solutions, Dionex recommends continuously rinsing the piston seal with a piston seal wash. Rinsing removes salt crystals that may abrade the piston, thereby causing the seal to wear out prematurely and allow leaks.

Dionex offers a continuous seal wash kit (P/N 059187) for the GP50. For installation instructions, see Section B.2.8 or the instructions included with the kit.

2.7 Eluent Reservoirs

NOTE Dionex strongly recommends degassing all eluents and storing them in reservoirs pressurized with helium. This helps prevent bubbles (resulting from eluent outgassing) from forming in the eluent proportioning valves, pump heads, and the detector cell.

Degassed eluents and pressurized reservoirs are especially important when combining aqueous and non-aqueous components (e.g., water and methanol). Pressurizable reservoirs allow eluents to be stored under a specific atmosphere.

The following pressurizable reservoirs are available from Dionex:

- 1-liter glass reservoirs with shatterproof plastic coating (P/N 044126)
- 2-liter glass reservoirs with shatterproof plastic coating (P/N 044127)
- 1-liter plastic reservoirs (P/N 044128)
- 2-liter plastic reservoirs (P/N 044129)



Do not use the 2-liter plastic reservoir (P/N 044129) for off-line vacuum degassing of eluents. The reservoir was not designed for this purpose.



N'utilisez pas le réservoir en plastique de 2 litres (N/P 044129) pour le dégazage à vide hors ligne d'éluants. Le réservoir n'a pas été conçu à cette fin.

Refer to the *Pressurizable Reservoir Installation Instructions* (Document No. 034581) for installation details.

E01 Eluent Organizer (Optional)

The Dionex E01 Eluent Organizer (P/N 044125) holds eluent reservoirs in a liner that contains spills and leaks. The E01 can also be used to pressurize reservoirs. Up to two optional E01 Eluent Organizers can be placed on top of the system

enclosure. Each organizer can accommodate one or two reservoirs, depending on the type of reservoir used (see the table below).

No. of Reservoirs	Description	Total Volume in Liters
2	1-Liter glass or plastic	2 L
2	2-Liter plastic	4 L
1	2-Liter glass	2 L

2.8 Rear Panel

The rear panel contains the main power receptacle and fuses. It also includes a DX-LAN connector for interfacing the GP50 with the PeakNet workstation. The rear panel is illustrated in Figure B-1.

2.9 Functional Description

2.9.1 Operating and Control Modes

The operating mode determines *how* the GP50 receives operating commands:

- In Local mode, the GP50 receives commands from the front control panel buttons and screens.
- In Remote mode, PeakNet 5 software sends commands from the host computer via the DX-LAN interface. Limited operating changes from the front panel are allowed.
- In Locked Remote mode, PeakNet 5 or PeakNet 6 software sends commands from the host computer via the DX-LAN interface. All operating changes from the front panel are disabled. When PeakNet 6 software is controlling the GP50, the pump is always in Locked Remote mode.

The control mode determines *when* operating commands are executed.

- In Direct control, the GP50 executes commands immediately. Because there is no time-based program, the method clock is not used and the **Hold/Run** and **Reset** buttons do not operate.

- In Method control, the GP50 executes commands according to the timed steps in a method. The method is programmed from the GP50 front panel or from PeakNet 5 software. See Section 2.9.3 for details about Method control from the front panel. For information about using PeakNet 5 to program and run methods, refer to the online Help or user's guide.

The table below summarizes the various operating and control mode configurations. Select the modes from the **MAIN** screen (see Section C.1.2), **DETAIL** screen (see Section C.1.3), or chromatography software.

Operating/Control Mode	Pump Operation
Local/Direct Control	Commands are entered from the GP50 front control panel and executed immediately after being entered.
Local/Method	Commands are entered from the GP50 front control panel and executed by running a method programmed from the front panel.
Remote/Direct Control	Commands are sent from PeakNet 5 and executed immediately when received.
Locked Remote/Direct Control	Commands are sent from PeakNet 5 or PeakNet 6 and executed immediately when received.
Remote/Method	Commands are sent from PeakNet 5 and executed by running a method programmed in PeakNet 5.

2.9.2 Local and Remote Modes

Local Mode

When the GP50 power is turned on, the pump is in Local mode. In Local mode the pump accepts operating commands from two sources:

- Direct input from the front panel keypad and screens. With direct input, all GP50 operating functions are available.
- TTL inputs from a remote controller (for example, a Dionex detector module or autosampler). TTL signals can be used to turn the pump motor on and off, turn the method clock on and off, and increment or decrement the method number.

Remote Mode

In Remote mode, PeakNet 5 software sends operating commands from the host computer via the DX-LAN interface. In Remote mode, operating parameters can be changed from the front panel, provided they do not interfere with a running method.

Locked Remote Mode

In Locked Remote mode, PeakNet 5 or PeakNet 6 software sends operating commands from the host computer via the DX-LAN interface. In Locked Remote mode, all operating changes from the front panel are disabled.

When the GP50 is controlled by PeakNet 5, select the Locked Remote Start option from the PeakNet 5 Run program to operate in the Locked Remote mode. To return the GP50 to Local mode, clear the Start option or turn the GP50 power off and then on.

When the GP50 is controlled by PeakNet 6, connecting to the PeakNet 6 timebase automatically selects the Locked Remote mode. To return the GP50 to Local mode, either clear the Connect check box on the PeakNet 6 control panel or turn the GP50 power off and then on.

2.9.3 Method Control

In Method control, commands are executed according to the time-based steps programmed in a method. Each step specifies the eluent composition and flow rate to be delivered by the pump at a given time. The selected eluent mixture is delivered either isocratically, or as a multistep linear or curved gradient. As the method runs, the GP50 calculates the changes in eluent composition required to deliver a gradient from one method step to the next or to match the selected curve.

Methods are programmed, saved, and edited from the **METHOD** screen (see Figure 2-9). See Section 3.3 for programming instructions.

METHOD EDIT 05				SAVE TO 06		RUN 10	
				LIMITs 0		- 5000 PSI	
TIME	%A	%B	%C	%D	C	V	FLOW
INIT	25.0	25.0	25.0	25.0	0	L	1.00 >
0.00	100.0	0.0	0.0	0.0		I	>
123.45	10.0	22.2	32.3	35.5	5	L	2.00 >
345.67	17.2	19.6	33.2	30.0			>

Help Message

Figure 2-9. Method Screen

NOTE For information about using PeakNet 5 to program and run methods, refer to the online Help or user's guide.

Here is a summary of basic information about using methods.

- Each method can contain up to 50 time-based steps. Step 1 always starts at **INIT** (initial condition). Step 2 always starts at **TIME = 0.0**.
- The GP50 can store up to 100 separate methods (0 through 99) in memory. Methods are retained in memory even after the pump is powered down.

IMPORTANT

The total number of methods that can be stored in memory depends on the length of each method and the amount of available memory; thus, the actual total may be less than 100.

- The pump can run under method control while you are entering or editing any method.
- When you save changes to the currently running method or switch to a different method, the method clock continues running unaffected. Only those parameter changes which affect the method *after* the current time will be implemented in the current run.

2.9.4 Eluent Delivery

Isocratic Eluent Run

The simplest use of the GP50 is for the delivery of an isocratic (unchanging) mixture of one or more eluents. If more than one eluent is selected, the pump delivers a proportional mixture of the eluents based on the percentage of each eluent selected. The combined percentages of all eluents selected must total 100% or the pump will not run.

Gradient Eluent Run

The GP50 can produce step, linear, concave, or convex curves in eluent concentration over a specified time period. The slope of the gradient is determined by the selected gradient curve (see Figure 2-10) and the time between the starting and ending points of a gradient step. It is important to note the following points:

- The curve number parameter determines whether the pump delivers a linear or curved gradient.

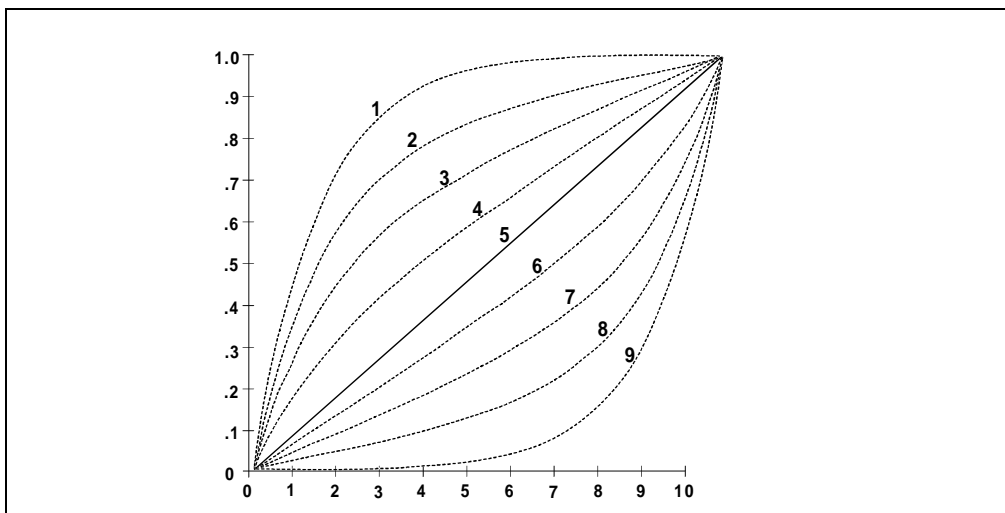

Figure 2-10. Eluent Composition Profile for Curves 1 - 9

Curve numbers are defined as follows:

Curve Number	Gradient Type
1, 2, 3, 4	Convex
5	Linear (power-up default)
6, 7, 8, 9	Concave

NOTE A curve number in a step instructs the pump to use the selected curve number when moving from the previous step to that step. Because there are no previous steps for INIT or TIME=0.0, curve numbers cannot be entered for these steps.

- The gradient slope does not change during a step if curve 5 (the default setting) is selected, because curve 5 represents a linear gradient.
- Convex curves cause rapid changes in eluent composition at the beginning of the curve and slower changes at the end. Concave curves cause slower changes at the beginning and rapid changes at the end.
- Slope changes over time become more extreme as curves go from 6 to 9 (more concave) and from 4 to 1 (more convex). Figure 2-10 shows the eluent composition profiles corresponding to curves 1 through 9, normalized for 0–100% for 10 minutes.
- Any consecutive method steps specifying identical eluent compositions will generate an isocratic segment, regardless of the curve number selected.
- A step change is a steep linear gradient in which the eluent composition changes from one eluent to another within 6 seconds.

3 • Operation and Maintenance

3.1 Getting Ready to Run

NOTE The GP50 Gradient Pump is designed to perform ion chromatography and BioLC applications only and should not be used for any other purpose. If there is a question regarding appropriate usage, contact Dionex.

3.1.1 Degas Eluents

Dionex strongly recommends degassing all eluents and storing them in reservoirs pressurized with filtered inert gas (see Section 3.1.3). This helps prevent bubbles caused by eluent outgassing from forming in the eluent proportioning valves, pump heads, and the detector cell. Degassed eluents and pressurized reservoirs are especially important when combining aqueous and nonaqueous components (e.g., water and acetonitrile).

The GP50 with the optional vacuum degas pump assembly provides continuous on-line vacuum degassing of up to four eluents.

If the GP50 is not equipped with the vacuum degas assembly, manually vacuum-degas eluents daily, as described below, and store them in pressurized reservoirs.

Degassing Eluents Manually

1. Prepare the eluent required for your application. Pour it into a vacuum flask and attach the flask to a vacuum pump or water aspirator.
2. Vacuum degas the eluent for 5-10 minutes by shaking or sonication.
3. Remove the flask from the vacuum. **Do not allow water to flow from the aspirator back into the flask.**
4. Pour the degassed eluent into a pressurizable reservoir. Be careful not to shake the eluent.
5. Install end-line filters and pressurize the reservoirs (see Sections 3.1.2 and 3.1.3).

3.1.2 Filter Eluents

Always filter eluents before beginning operation. Filtering removes small particulates that may contaminate the eluent proportioning valves or the pump check valves and cause erratic flow rates or loss of prime. The pressurizable reservoir Ship Kits supply end-line filters (P/N 045987) for this purpose.

Install an end-line filter on the end of each eluent line inside the reservoir. To prevent air from being drawn through the lines, make sure that the end of each filter reaches the bottom of the eluent reservoir and that each filter is submerged in eluent.

3.1.3 Pressurize Eluent Reservoirs

The GP50 Gradient Pump is capable of operation with or without head pressure on the eluent. Pressurization of the eluent reservoirs, if used, should be with filtered inert gas (preferably helium). Refer to the *Pressurizable Reservoir Installation Instructions* for details.

1. Verify that a regulator (P/N 046594) is installed on the gas supply line to the reservoirs.
2. Turn on the gas supply and adjust the pressure to 55 KPa (8 psi).



Never pressurize the reservoirs above 69 KPa (10 psi).



Ne mettez jamais les réservoirs d'éluants sous une pression supérieure à 69 kPa (10 lb/po²).

3.1.4 Start-Up

1. Turn on the main pump switch.

The **POWER-UP** screen displays briefly (see Figure 2-3) and then the **MAIN** screen displays (see Figure 2-4). A series of diagnostics tests is run at power-up. If one of the tests fails, the **DIAGNOSTIC TEST** screen displays instead. See Section C.2.7 if this occurs.

When the GP50 power is turned on, the injection valve is initialized to the Load position.

2. Press **Off/On** to start the pump flow.
3. Check the pressure reading on the **MAIN** screen. The GP50 display updates the pressure readout once per piston stroke. The reading from one stroke to the next should be within 3%.

A variation of more than 3% indicates that the pump is out of prime. Refer to Section B.2.8 for priming instructions, or see Section 4.1 for other conditions which can cause the pump to lose prime.

NOTE After starting the pump or changing the flow rate, wait at least 5 minutes (up to 20 minutes for low flow rates in a standard bore pump) before beginning an analysis. This allows the pump's real-time electronic pulse damping circuitry to stabilize the flow rate.

3.1.5 Selecting the Pressure Limits

The high and low pressure limits automatically stop the pump if a system malfunction occurs, such as overpressurization caused by a blockage or low pressure caused by a leak downstream from the pump.

- When PeakNet is controlling the pump, select the pressure limits from the software.
- When the pump is running under Local mode, Direct control, enter the pressure limits on the **DETAIL** screen (see Figure 3-1).
- When the pump is running under Local mode, Method control, enter the pressure limits on the **METHOD** screen (see Figure 3-5). The limits are set in the **INIT** step and remain unchanged throughout the analysis. When a limit trip stops the pump, the method clock immediately stops and goes to Hold. The current status of the program that was running at the time is displayed on the front panel.

To select the pressure limits from the front panel:

1. Go to the **DETAIL** or **METHOD** screen and move the cursor to the **LIMIT** field.
2. Enter a low pressure limit between 1.4 and 2.8 MPa (200-400 psi).

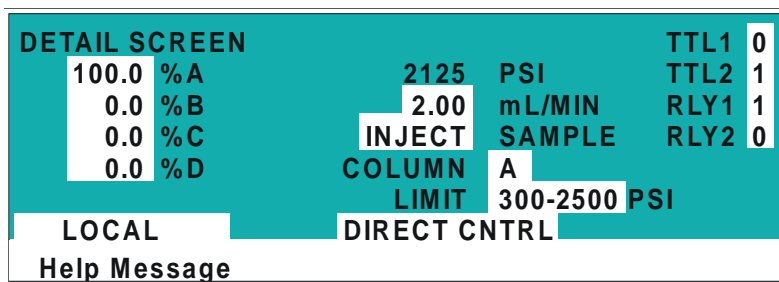

Figure 3-1. Detail Screen: Setting Pressure Limits

The setting may vary, depending on the system operating pressure. The low pressure limit is activated after 13 pump piston strokes (i.e., after 1.3 mL (standard bore) or 0.325 mL (microbore) of fluid is pumped through).

3. Enter a high pressure limit that is 2.8 to 3.4 MPa (400-500 psi) above the normal system operating pressure. The pump is equipped with a pressure limit that prevents operation above 35 MPa (5076 psi).

3.1.6 Selecting the Operating and Control Modes

1. Go to either the **MAIN** or **DETAIL** screen. The operating mode field displays **LOCAL**, **REMOTE**, or **LOCKED RMT**. The control mode field displays **DIRECT CNTRL** or **METHOD**. See the example in Figure 3-2.
2. To select the operating mode:
 - If the GP50 is controlled by PeakNet 6, connecting to the PeakNet 6 timebase automatically selects **LOCKED RMT**. To return the GP50 to **LOCAL**, either clear the Connect check box on the PeakNet 6 control panel or turn the GP50 power off and then on.
 - If the GP50 is controlled by PeakNet 5, select **LOCAL** or **REMOTE** on the **MAIN** or **DETAIL** screen. Move the cursor to the field, press **Select** Δ or **Select** ∇ to toggle to the desired mode, and press **Enter** or a cursor arrow button.

To select **LOCKED RMT** with PeakNet 5, select the Locked Remote Start option from the Run program. To return the GP50 to **LOCAL**, clear the Start option or turn the GP50 power off and then on.
3. To select the control mode, move the cursor to the field, press **Select** Δ or **Select** ∇ to toggle to the desired mode, and press **Enter** or a cursor arrow button.

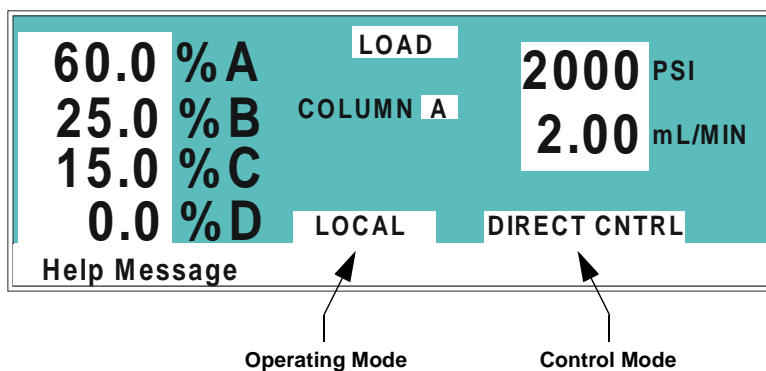

Figure 3-2. Main Screen: Operating and Control Mode Fields

3.2 Running Under Direct Control (Local Mode)

Direct Control, Local mode is used most often when a PeakNet workstation is not configured.

Direct Control Example

Specify an isocratic mixture of 60% eluent A, 25% eluent B, and 15% eluent C to be pumped at 2.0 mL/min (see Figure 3-3).

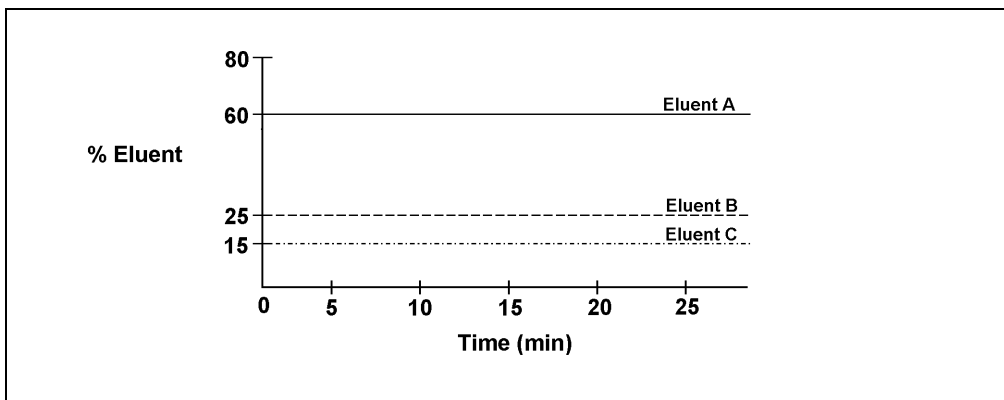

Figure 3-3. Isocratic Run Profile

1. Go to the **MAIN** or **DETAIL** screen and if necessary, change the operating and control modes to **LOCAL** and **DIRECT CNTRL** (see Section 3.1.6).

Figure 3-4 illustrates the **MAIN** screen as it will appear when the example is set up.

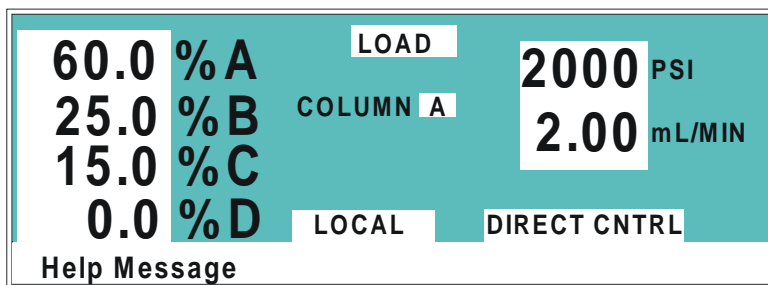

Figure 3-4. Main Screen: Running Under Direct Control

2. Move to the **%A** field and enter 60; move to the **%B** field and enter 25; move to the **%C** field and press **Enter** (15 is automatically filled in to make the eluent percentages equal 100).
3. Move to the **mL/MIN** field and enter 2.
4. If the pump is currently off, press **Off/On** to turn on the motor and begin the isocratic delivery.

NOTE After starting the pump or changing the flow rate, wait at least 5 minutes (up to 20 minutes for low flow rates in a standard bore pump) before beginning an analysis. This allows the flow rate to stabilize.

3.3 Running Under Method Control (Local Mode)

This section provides general instructions on how to create, edit, and run methods from the GP50 front panel. For step-by-step examples, see Section 3.4.

When entering parameters on the **METHOD** screen, observe these guidelines:

- After starting the pump or changing the flow rate, wait at least 5 minutes (up to 20 minutes for low flow rates in a standard bore pump) before beginning an analysis. This allows the flow rate to stabilize.
- In the **%A**, **%B**, **%C**, and **%D** columns, enter decimal percentage values from 0.1% through 100% for the eluent compositions. The combined percentages for all eluents must total 100% or the pump will not run.
- In the **V** column, select the injection valve position (**L** for load or **I** for inject).
- In the **FLOW** column, enter the pump flow rate. Flow rates are adjustable in increments of 0.01 mL/min. See Section 2.4.2 for the available flow rate ranges. They vary, depending on the size of the pump head and whether the run is isocratic or gradient.

IMPORTANT

Continuous operation of the microbore pump at flow rates above 2.0 mL/min will decrease seal and pump life. For optimum performance above 2.0 mL/min, a standard bore pump should be used.

- For steps other than **INIT** and **TIME=0.0**, enter a curve number in the **C** column. The curve number determines whether the pump delivers a linear or curved

gradient when moving to the step from the one preceding it (see Section 2.9.4). The default is curve 5 (linear).

NOTE Because there are no previous steps for **INIT** or **TIME=0.0**, curve numbers are not entered for them.

- If a step field is “blank” (has no entry), the last selected value for the field remains in effect.
- The symbol \vee next to the bottom time entry indicates there are additional steps below. Move the cursor to the bottom time entry and press the down arrow to see the additional step(s).
- The symbol \wedge next to the top time entry indicates that it is preceded by at least one more step. Move the cursor to the entry and press the up arrow to see the additional step(s).
- The symbol $>$ at the right edge of each line indicates a lateral extension to the line. Move the cursor to the end of a line and press the right arrow to display the **METHOD** extension screen (see Section C.1.5).

3.3.1 Creating a New Method

You can create a new method when the method clock is in either **Hold** or **Run**.

1. Go to the **MAIN** or **DETAIL** screen and if necessary, change the operating and control modes to **LOCAL** and **METHOD** (see Section 3.1.6).
2. Go to the **METHOD** screen.
3. In the **EDIT** field, enter the number of the method to be created. This can be the number of an unused method or of an existing method that you plan to edit and save as a new method. If you enter the number of an unused method, the screen will look similar to the example screen in Figure 3-5.

METHOD EDIT		5		SAVE TO		5		RUN		0	
				LIMITs		0		-		5000 PSI	
TIME	%A	%B	%C	%D	C	V	FLOW				
INIT	100.0				-	L	1.00	>			
0.00					-			>			
								>			
								>			

Help Message

Figure 3-5. Method Screen: Creating a New Method

4. In the **LIMITs** field, set the low and high pressure limits (see Section 3.1.5).
5. Each method starts out with two timed steps (see Figure 3-5): an initial conditions step (containing **INIT** in the **TIME** column) and a time zero step (containing 0.00 in the **TIME** column). The parameters in each of these first two steps can be changed but the steps cannot be deleted. Enter the parameters for both steps.
6. Enter a new step using one of the following methods:
 - Move the cursor to the empty **TIME** field below the last step and enter the elapsed time at which to start the new step. Press **Enter** or a cursor arrow button.
 - Move the cursor to any of the **TIME** fields and press **Insert**. This adds a new step after the cursor position. Enter the elapsed time at which to start the new step and press **Enter** or a cursor arrow button.

After entering a new step, all timed steps are automatically organized in chronological order.

7. Continue entering parameters for the new step. When you finish, move the cursor to the **SAVE TO** field and do one of the following:
 - If you are editing an existing method, enter a new number for the method and press **Enter**.
 - If you are editing an unused method, press **Enter**.

3.3.2 Running a Method

1. If the pump motor is off, press **Off/On** to turn on the motor.
2. Go to the **MAIN** or **DETAIL** screen and if necessary change the operating and control modes to **LOCAL** and **METHOD** (see Section 3.1.6).
3. In the **METHOD #** field, enter the desired method number. If the method clock is already running, the method starts immediately. If the clock is in Hold, press **Hold/Run** to start the method.

NOTE You can also select the method number in the **METHOD** screen. Move the cursor to the **RUN** field and enter the desired method number.

4. The elapsed time on the method clock when the method begins determines where (at what step and parameters) the method begins running:
 - If the method clock is at **INIT** or time zero, the method begins running using the **INIT**ial condition parameters.
 - If the method clock is greater than zero, the method begins running using the parameters specified in the step for that elapsed time. To start the method at the **INIT**ial conditions instead, press **Reset**.

3.3.3 Editing a Method

Existing methods can be modified by changing, adding, or deleting steps and parameters. Changes can be made when the method clock is stopped or running. If the method you are editing is currently running, the changes are stored in memory and implemented when you save the method.

NOTE After saving changes, there is no way to recall the original method. If you plan to make experimental changes to a method but also want to retain the original method, save the modified method to a new number.

To edit a method:

1. Go to the **METHOD** screen. In the **EDIT** field, enter the number of the method to be modified.
2. Make the required changes:
 - *To change a parameter*, position the cursor in the field and enter the new value. The previous value is automatically deleted.
 - *To add a method step*, move the cursor to any **TIME** field and press **Insert**, or move the cursor to the empty **TIME** field below the last step and enter the elapsed time at which to start the new step. When you press **Enter** or a cursor arrow button, the new step is automatically moved to the correct chronological position. Continue entering parameters for the new step.
 - *To delete a method step*, move the cursor to the step to be deleted and press **Delete** twice.
3. When changes are complete, move the cursor to the **SAVE TO** field. Press **Enter** to save the changes to the current method, or enter a new method number and press **Enter**.

If you save changes to the currently running method, they are immediately incorporated in the run and executed at the programmed time, *unless* the modified event has already been executed. To restart the method at the **INITIAL** conditions and run all steps of the updated method, press **Reset**.

3.3.4 Deleting a Method

To delete an entire method, move the cursor on the **METHOD** screen to the **INIT** step and press **Delete** twice.

3.3.5 Changing the Running Method

To change from the method currently running to a different method, go to the **MAIN** or **DETAIL** screen, enter the new method number in the **METHOD** field, and press **Enter**.

The new method will begin running, using the parameters specified in the step for the current elapsed time. To start the method at the **INITIAL** conditions, press **Reset**.

3.3.6 Controlling the Method Clock

The **Hold/Run** button, the **Reset** button, and the **MIN** fields in the **MAIN** and **DETAIL** screens control the method clock:

- To start and stop the method clock, press **Hold/Run**.
- To reset the clock to **INITIAL** conditions, press **Reset**.
- To set the clock to a specific elapsed time, enter the time in the **MIN** field on the **MAIN** or **DETAIL** screen. The method will start (or continue) running, using the method parameters specified for that time.

3.4 Example Methods

The examples in this section provide step-by-step instructions for creating three types of methods: isocratic, linear gradient, and curved gradient. The last example demonstrates how to edit a running method.

For all of the examples, set the pump to **LOCAL** mode, **METHOD** control (see Section 3.1.6).

3.4.1 Isocratic Method Example

Specify an isocratic mixture of 60% eluent A, 25% eluent B, and 15% eluent C to be pumped at 2.0 mL/min. Figure 3-3 illustrates the isocratic profile for this example. Figure 3-6 illustrates the **METHOD** screen as it appears when the example is set up.

METHOD EDIT		1		SAVE TO		1		RUN		0	
				LIMITs		0 - 5000		PSI			
TIME	%A	%B	%C	%D	C	V	FLOW				
INIT	60.0	25.0	15.0		-	L	2.00	>			
0.00					-			>			
								>			
								>			

Help Message

Figure 3-6. Method Screen: Isocratic Run Example

- Go to the **METHOD** screen and enter a method number in the **EDIT** field (1, for example). The screen automatically changes the number in the **SAVE TO** field to the number of the method being edited.
 - If Method 1 currently exists and you want to retain it, enter a new, unused, method number in the **EDIT** field.
 - If Method 1 currently exists and you want to delete it, move the cursor to **TIME=INIT** and press **Delete** twice.
- Move the cursor to the **%A** field and enter 60; move to the **%B** field and enter 25; move to the **%C** field and press **Enter** (15 is automatically filled in to make the eluent percentages equal 100). Ignore the **C** (Curve) and **V** (Valve) fields. Move to the **FLOW** field and enter a flow rate of 2.00.

3. Move the cursor to **SAVE TO** and press **Enter** to save the method.
4. Move the cursor to **Run**, enter the method number (1, in this case) and press **Enter** to select the programmed method. If the pump motor is off, press **Off/On** to have the pump start delivering the eluent mixture.
5. If the method clock is in hold, press **Hold/Run** to begin running the method.

3.4.2 Linear Gradient Method Example

The following summarizes the linear gradient method steps:

- Create Method 2 to begin under isocratic conditions with 100% eluent A at 2.0 mL/min.
- After 5 minutes, begin adding eluent B and decreasing eluent A until, at 10 minutes, the mixture is 65% eluent A and 35% eluent B.
- Begin adding eluent C to the mixture while continuing to decrease eluent A and increase eluent B until, at 15 minutes, the eluent composition is 0% eluent A, 50% eluent B, and 50% eluent C.
- Continue increasing eluent C and begin decreasing eluent B until, at 25 minutes, the eluent composition is 100% eluent C.
- Make a step change to 100% eluent D at 25.01 minutes. Pump 100% eluent D for 4.99 minutes.
- At 30.01 minutes, return to 100% eluent A and re-equilibrate your system for the next analysis.

Figure 3-7 illustrates the gradient profile for this method.

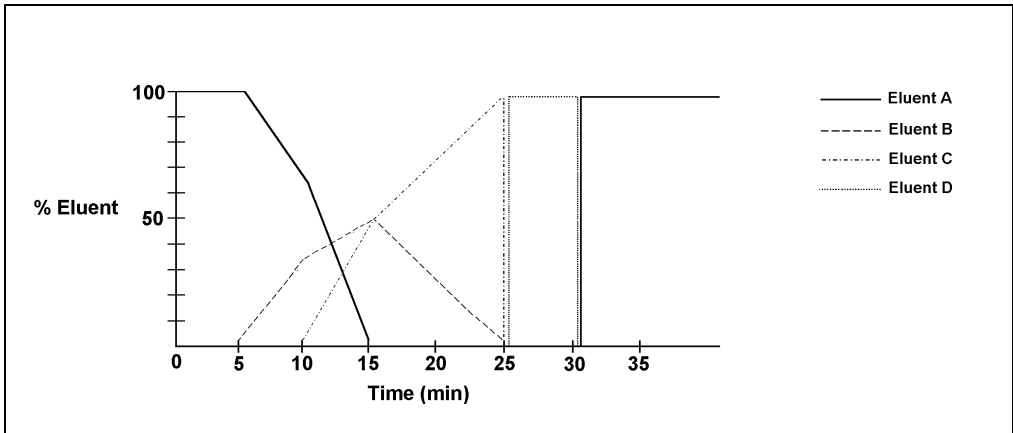

Figure 3-7. Linear Gradient Method Profile

1. Go to the **METHOD** screen and enter a method number in the **EDIT** field (2, for example).
 - If Method 2 currently exists and you want to retain it, enter a new, unused, method number in the **EDIT** field.
 - If Method 2 currently exists and you want to delete it, move the cursor to **TIME = INIT** and press **Delete** twice.
2. Move to the **FLOW** field of the **INIT** step and enter a flow rate of 2.00.

Figure 3-8 illustrates the **METHOD** screen as it appears so far. You can now begin entering the method steps that will generate the gradient profile.

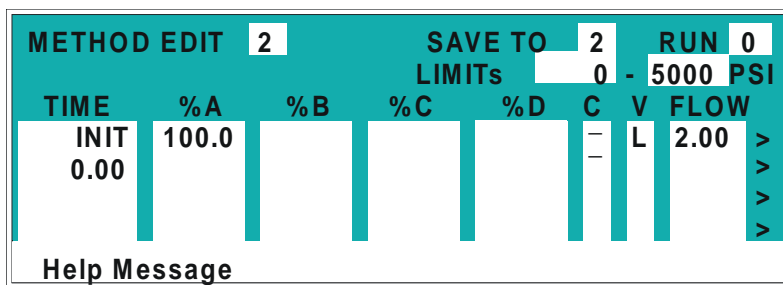

Figure 3-8. Linear Gradient Method Example (After Step 2)

3. Move the cursor to the **%A** field of the **TIME = 0** step and press **Enter**. 100% of eluent A is automatically filled in.
4. Move the cursor to the line below **TIME = 0**, and enter 5 to store a step at **TIME = 5.0** minutes. Then move the cursor to **%A** and press **Enter** to enter 100% and define a step with the same eluent composition as the previous step. Although there is no change in eluent parameters, the 100% of %A must be entered at 5.00 minutes to establish 5.00 as the gradient start point.

This marks the end of the isocratic section of the run and the beginning of the eluent B concentration ramp. From this point on, the concentration of eluent A decreases from 100% as the concentration of eluent B begins to increase from 0%.

5. Move the cursor to the next line. Enter 10 in the **TIME** field. Move the cursor to the **%A** field and enter 65, followed by 35 in the **%B** field.

After a total of 10 minutes (5 minutes of isocratic conditions plus 5 minutes to gradually decrease the amount of eluent A in the mixture while increasing the amount of eluent B), the eluent composition is 65% eluent A and 35% eluent B.

This step marks the end of the second segment and the beginning of the eluent C concentration ramp. Figure 3-9 illustrates the **METHOD** screen as it appears after Step 5.

METHOD EDIT		2		SAVE TO		2		RUN		0	
				LIMITs		0		-		5000 PSI	
TIME	%A	%B	%C	%D	C	V	FLOW				
INIT	100.0				-	L	2.00	>			
0.00	100.0				-			>			
5.00	100.0							>			
10.00	65.0	35.0						>			
Help Message											

Figure 3-9. Linear Gradient Method Example (After Step 5)

6. Move the cursor to the next line. Enter 15 in the **TIME** field. Move the cursor to the **%B** field and enter 50, followed by 50 in the **%C** field.

Beginning with the method step immediately preceding this one (**TIME=10**), the pump begins adding eluent C, starting with 0%. When the method reaches this step (after 15 minutes), eluent C is at 50%, eluent B at 50%, and eluent A at 0%.

7. Move the cursor to the next line. Enter 25 in the **TIME** field. Move the cursor to **%C** and enter 100.

After a total of 25 minutes, the concentration of eluent B drops to 0% and the concentration of eluent C increases to 100%.

8. Move the cursor to the next line. Enter 25.01 in the **TIME** field. Move the cursor to **%D** and enter 100.

The concentration of eluent C drops to zero and the concentration of eluent D, which the pump began adding 0.6 seconds (0.01 min) earlier, reaches 100%. This is a *step change* in eluent composition to 100% eluent D. A step change is a very steep linear gradient in which the eluent composition changes from one eluent to another in 6 seconds. Figure 3-10 illustrates the **METHOD** screen as it appears after Step 8.

METHOD EDIT		2		SAVE TO		2		RUN		0	
				LIMITs		0		-		5000 PSI	
TIME	%A	%B	%C	%D	C	V	FLOW				
10.00	65.0	35.0					2.00	>			
15.00		50.0	50.0					>			
25.00			100.0					>			
25.01				100.0				>			
Help Message											

Figure 3-10. Linear Gradient Method Example (After Step 8)

9. Move the cursor to the next line. Enter 30 in the **TIME** field. Move the cursor to the **%D** field and enter 100. The eluent composition remains unchanged at 100% eluent D for 4.99 minutes.
10. Move the cursor to the next line and enter 30.01 in the **TIME** field. Move the cursor to the **%A** field and enter 100. This causes another step gradient from 100% D to 100% A.

11. Move the cursor to the **SAVE TO** field and press **Enter** to save the method to memory. Figure 3-11 illustrates the completed method.

METHOD EDIT		2		SAVE TO		2		RUN		0	
				LIMITs		0 - 5000 PSI					
TIME	%A	%B	%C	%D	C	V	FLOW				
25.00	↑		100.0				2.00				>
25.01				100.0							>
30.00				100.0							>
30.01	100.0										>

Help Message

Figure 3-11. Linear Gradient Method Example (Complete)

12. Press **MENU** and **Enter** to go to the **MAIN** screen. Enter 2 in the **METHOD** field. Press **Reset** to reset the method to the **INIT** step (if necessary).
13. If the pump motor is off, press **Off/On** to start the pump.
14. If the method clock is in hold, press **Hold/Run** to start the method running. When the method reaches the last step in the method (**TIME = 30.01**), the pump will continue to pump isocratically until the clock is reset.

3.4.3 Curved Gradient Method Example

When attempting to optimize the separation of a single component in a complex mixture, it is often helpful to employ paired segments of a curved gradient. For example, if the analyte is an oligonucleotide that elutes with 0.32 M NaCl in a linear gradient run, you can move potentially interfering components of the sample away from the target oligonucleotide by first programming a segment from 0% to 32% of a 1 M NaCl solution using curve 2. Then, program a segment from 32% to 100% of 1 M NaCl using curve 8. The resulting gradient profile is shown in Figure 3-12.

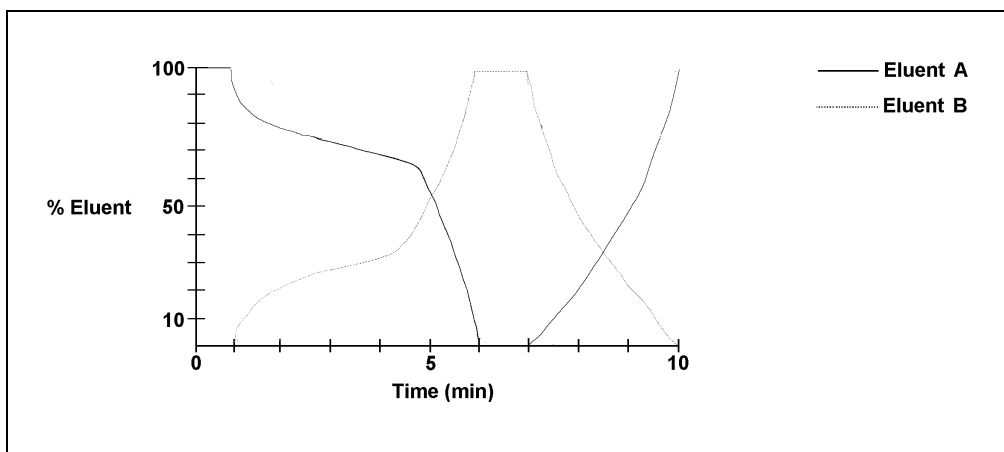

Figure 3-12. Gradient Curve Profile

In binary curve gradients, two elements follow curves which are mirror images (e.g., E1 = Curve 8 and E2 = Curve 1 in Figure 3-13). See Section 2.9.4 for details about gradient curves.

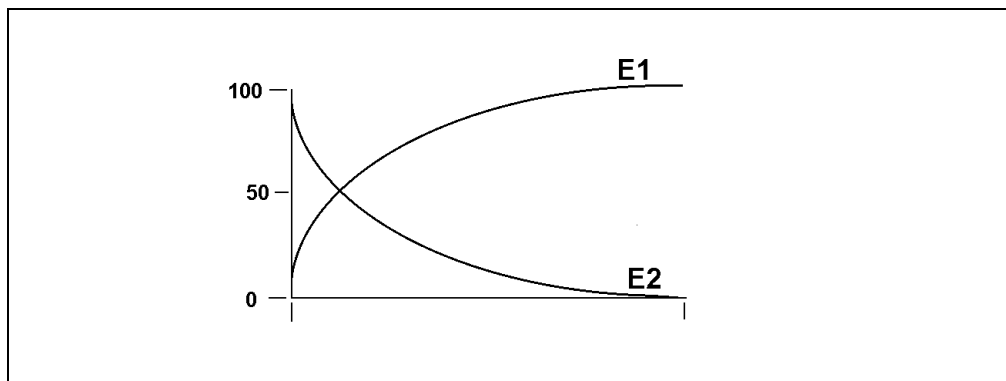

Figure 3-13. E1 and E2 Curves

The following summarizes the curved gradient method example steps:

- Create Method 3 to begin under isocratic conditions with 100% eluent A (25 mM Tris buffer, pH 8.0) at 1.5 mL/min.
 - After 1 minute, begin a convex addition of eluent B (25 mM Tris buffer, pH 8.0, containing 1.0 M NaCl) while decreasing eluent A until, after 2.5 minutes (elapsed time = 3.5 minutes), the mixture is 68% eluent A and 32% eluent B.
 - Begin a 2.5-minute concave segment in which the amount of eluent A is decreased and the amount of eluent B is increased until the mixture is 100% eluent B (elapsed time = 6 minutes).
 - At 7 minutes, begin a 3-minute concave segment, reducing eluent B to 0% and increasing eluent A to 100% (total elapsed time = 10 minutes).
1. Go to the **METHOD** screen and enter a method number in the **EDIT** field (3, for example).
 - If Method 3 currently exists and you want to retain it, enter a new, unused method number in the **EDIT** field.
 - If Method 3 currently exists and you want to delete it, move the cursor to **TIME = INIT** and press **Delete** twice.
 2. Move to the **FLOW** field of the **INIT** step and enter a flow rate of 1.50.

Figure 3-14 illustrates the **METHOD** screen as it appears so far. You can now begin entering the method steps that will generate the curved gradient profile (see Figure 3-13).

METHOD EDIT		3		SAVE TO		3		RUN		0	
				LIMITs		0		-		5000 PSI	
TIME	%A	%B	%C	%D	C	V	FLOW				
INIT	100.0				-	L	1.50	>			
0.00					-			>			
								>			
								>			
Help Message											

Figure 3-14. Curved Gradient Method Example (After Step 2)

3. Move the cursor to the **%A** field of the **TIME = 0** step and press **Enter**. 100% of eluent A is automatically filled in.
4. Move the cursor down to the next line and enter 1 in the **TIME** field, and then move to the **%A** field and enter 100.

This marks the end of the isocratic section of the run and the beginning of the eluent B concentration ramp. At this point, the concentration of eluent A begins to decrease from 100% as the concentration of eluent B begins increasing from 0%.

5. Move the cursor down to the next line and enter 3.5 in the **TIME** field. Move the cursor to **%A** and enter 68. Move the cursor to **%B** and enter 32.
6. Move the cursor to the **C** field and enter 3 to run gradient curve 3.

After a total of 3.5 minutes (1 minute of isocratic conditions plus 2.5 minutes to gradually decrease the amount of eluent A in the mixture while increasing the amount of eluent B), the eluent composition is 68% eluent A and 32% eluent B. Figure 3-15 illustrates the **METHOD** screen as it appears after Step 6.

METHOD EDIT		3		SAVE TO		3		RUN		0	
				LIMITs		0		-		5000 PSI	
TIME	%A	%B	%C	%D	C	V	FLOW				
INIT	100.0				-	L	1.50	>			
0.00	100.0				-			>			
1.00	100.0							>			
3.50	68.0	32.0			3			>			

Help Message

Figure 3-15. Curved Gradient Method Example (After Step 6)

7. Move the cursor to the next line and enter 6 in the **TIME** field. Move the cursor to **%B** and enter 100.
8. Move the cursor to the **C** field and enter 8.
After a total of 6 minutes, the eluent composition is 0% eluent A and 100% eluent B.
9. Move the cursor to the next line and enter 7 in the **TIME** field. Move the cursor to **%B** and enter 100. The eluent composition remains unchanged at 100% eluent B for 1 minute.
10. Move the cursor to the next line and enter 10 in the **TIME** field. Move the cursor to **%A** and enter 100. After a total of 10 minutes, the concentration of eluent B drops to zero and the concentration of eluent A increases to 100%. Figure 3-16 illustrates the completed **METHOD** screen.

METHOD EDIT		3		SAVE TO		3		RUN		0	
				LIMITs		0		-		5000 PSI	
TIME	%A	%B	%C	%D	C	V	FLOW				
3.50	68.0	32.0			3		1.50	>			
6.00		100.0			8			>			
7.00		100.0						>			
10.00	100.0							>			

Help Message

Figure 3-16. Curved Gradient Method Example (Complete)

11. Move the cursor to the **SAVE TO** field and press **Enter** to save the method to memory.

3.4.4 Editing a Running Method Example

After entering a method, you can modify it by changing, adding, or deleting steps.

The example describes how to make the following changes to Method 2, the linear gradient example (see Section 3.4.2):

- Change the eluent composition at **TIME = 15** from 50% eluent B and 50% eluent C to 45% eluent B and 55% eluent C.
- Add a step to Method 2 at **TIME = 20.0** to make the eluent composition 40% eluent B and 60% eluent C.

Figure 3-17 illustrates the **METHOD** screen as it will appear when editing is complete. Figure 3-18 illustrates the edited gradient profile.

METHOD EDIT		2		SAVE TO		2		RUN		2	
				LIMITs		0 - 5000 PSI					
TIME	%A	%B	%C	%D	C	V	FLOW				
10.00	65.0	35.0					2.00	>			
15.00		45.0	55.0					>			
20.00		40.0	60.0					>			
25.00			100.0					>			

Help Message

Figure 3-17. Edited Linear Gradient Method Example

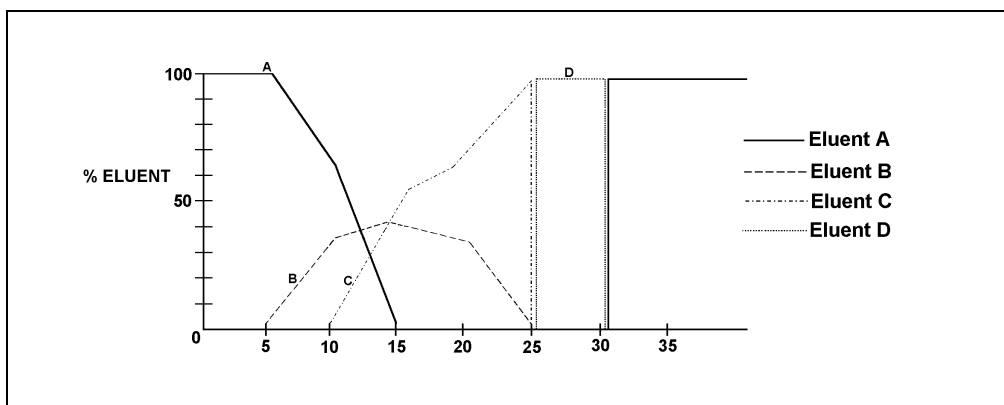

Figure 3-18. Gradient Profile After Editing

This example assumes that the example Method 2 is currently running.

1. Go to the **METHOD** screen and enter 2 in the **EDIT** field.
2. Move the cursor down through Method 2 until you reach the **TIME = 15** step. Move the cursor to **%B** and enter 45. Move the cursor to **%C** and enter 55.
3. Move the cursor to the **TIME** field and press **Insert**. Enter 20 in the time field. Move the cursor to **%B** and enter 40. Move the cursor to **%C** and enter 60.
4. Move the cursor to the **SAVE TO** field and press **Enter**.
5. Press **Menu** and select either the **MAIN** screen or **DETAIL** screen. Check the status of the method clock:
 - If the elapsed time is less than 15 minutes (the time for the first change made to the method), the changes will be incorporated into this run and executed at the programmed time.
 - If the elapsed time is greater than 15 minutes, the changes will not be incorporated into this run. To put the changes into effect, either press **Reset** to set the method clock to the **INITIAL** conditions, or enter an elapsed time in the **MIN** field that is less than 15 (10, for example). The method will restart, using the parameters programmed for **TIME = 10**, and the method changes will be incorporated at the programmed time.

3.5 Routine Maintenance

This section describes routine maintenance procedures to be performed by the user. Any other maintenance procedures must be performed by qualified Dionex personnel.

3.5.1 Daily Maintenance

- When using a combination of eluents which contain both salt or base and solvent, rinse the piston seals frequently or continuously. Eluent tends to crystallize as the solvent evaporates; these crystals can abrade the pistons and cause the piston seals to leak. Rinse the piston seals before and after operation each day as described in the following steps, or install a continuous seal wash kit (P/N 059187), to rinse the piston seals continuously (see Section B.2.8).
 1. Open the lower pump door and locate the two rinse ports on the front of each of the pump heads. Figure 3-19 shows the rinse port connections.
 2. Install a rinse waste tube (P/N 054418), provided in the GP50 Ship Kit, onto each head (see Figure 3-19).

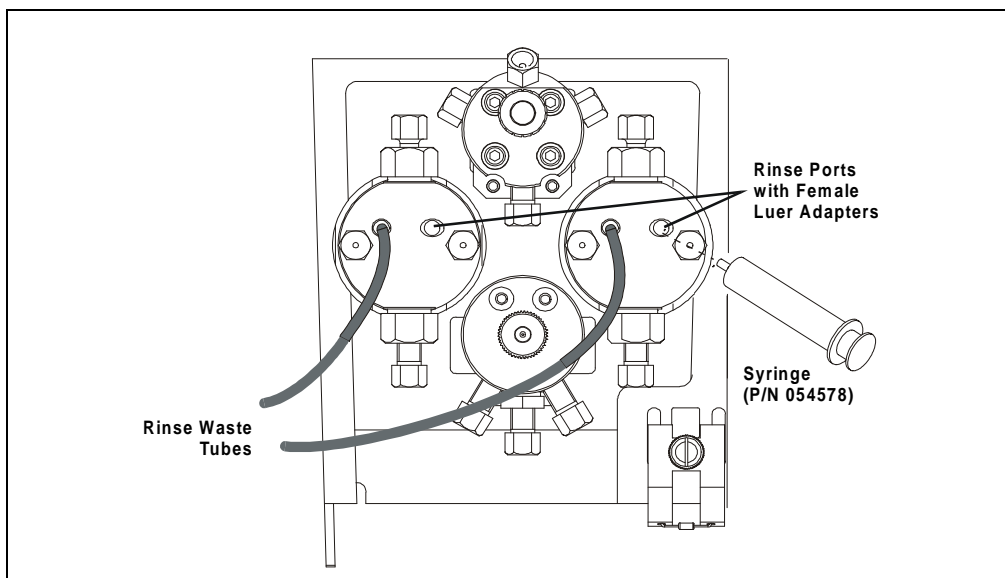

Figure 3-19. Rinsing the Piston Seals

- Place the end of each rinse waste tube into a waste receptacle. Attach a small syringe (P/N 054578) containing 5 to 10 mL of deionized water to the rinse inlet female luer adapter on one of the pump heads.
 - Inject deionized water into the fitting to rinse the pump heads.
 - Repeat Steps 3–4 for the other pump head.
 - Dispose of the waste water and close the door to the mechanical chassis.
- Check the entire mechanical chassis for leaks from the rinse ports, the eluent manifold connections and valves, the vacuum degas chambers, and the eluent reservoirs (see Figure 3-20). Tighten or replace any leaking fittings. Wipe up liquid spills and rinse dried reagents off the pump components with deionized water.
 - Dionex recommends thoroughly flushing the vacuum degas assembly with deionized water after each use. Flushing chemicals out of the degas chambers and tubing avoids crystallization in the membrane pores.

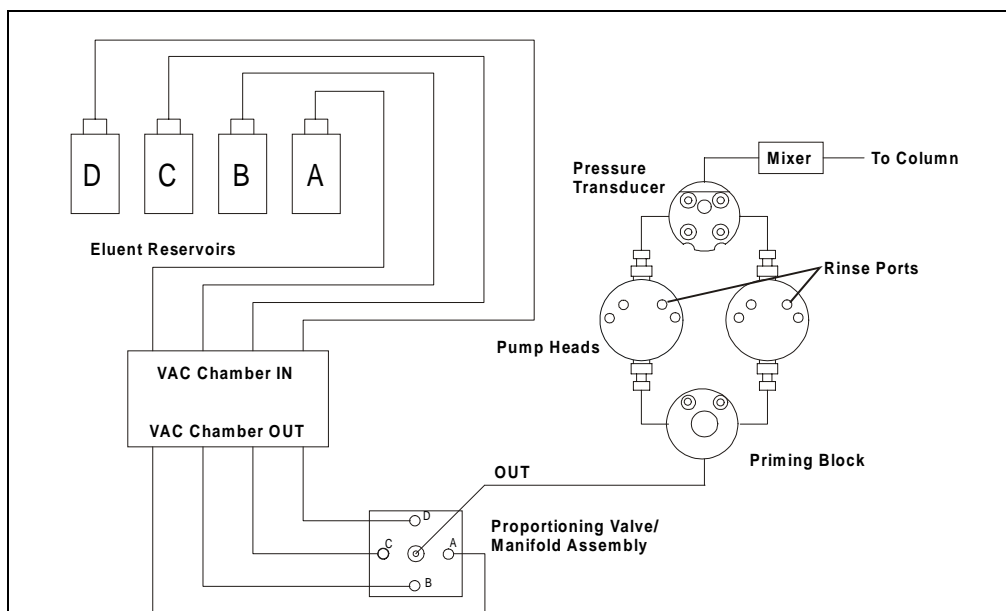

Figure 3-20. Eluent Flow Schematic

3.5.2 Periodic Maintenance

- Replace both the primary and rinse seals in each pump head approximately every 6 months. The seals may need to be replaced more often if you routinely run high pressures or high flow rates, or if you operate the pump continuously.

3.6 Shutdown

- Rinse the pump piston seals before and after daily operation to prevent build-up of salt crystals or other contaminants that can damage the piston seals (see Section 3.5.1).
- Before a shutdown of three days or more, flush the system with deionized water to prevent contaminants from building up. Or, if this is not possible, maintain a continuous rinse through the system until you resume normal operation. Select a flow rate of 0.04 mL/min for standard bore pump heads or 0.01 mL/min for microbore pump heads, and set all four valves in the eluent manifold to 25% so that the valves are also flushed.



Flushing the eluent manifold is extremely important if your eluents have a combination of salt or base and solvent. If salt precipitates in the valves, the valve diaphragms may be seriously damaged. If this happens, you will have to replace the entire valve assembly.

- Before a shutdown of more than three days, reduce the pressure on the eluent reservoir(s) to approximately 21 KPa (3 psi).
- Shut down the pump by turning off the main power on the GP50.

4 • Troubleshooting

This chapter is a guide to troubleshooting minor problems that may occur while operating the GP50 Gradient Pump. To use this guide, turn to the section that best describes the operating problem. There, possible causes of the problem are listed in order of probability.

If you are unable to resolve a problem, contact Dionex Technical Support. In the U.S., call 1-800-346-6390. Outside the U.S., call the nearest Dionex office.

4.1 Left-Right Pump Head Pressure Fluctuations

The GP50 display updates the pressure readout once per piston stroke. A variation of more than 3% from one stroke to the next indicates a problem.

- **Pump out of prime; there is no eluent**
 1. Refill the eluent reservoirs. Also make sure that each eluent line extends to the bottom of the reservoir.
 2. Reprime the pump (see Section B.2.8).
- **Pump out of prime; eluents are improperly degassed**
 1. If the GP50 is not equipped with the optional vacuum degas pump assembly, degas the eluents manually (see Section 3.1.1). Reprime the pump (see Section B.2.8).
 2. If the GP50 is equipped with the optional vacuum degas pump assembly, test the degas pump:
 - a. Open the **DEGAS STATUS** screen (press **Menu, 8, 8, and 3**). Press a **Select** button to toggle the **TEST** field to **RUN** and press **Enter**.
 - b. The degas pump should turn on and run for about 2 minutes. If it does not run (see Section 4.6).
- **Pump out of prime; end-line filter is dirty or clogged**
 1. Replace the filter (P/N 045987).
 2. Reprime the pump (see Section B.2.8).

- **Pump out of prime; blockages in inlet tubing**

Kinked or clogged tubing causes the pump to be “starved” for eluent. Replace the tubing and fittings. Reprime the pump (see Section B.2.8).

- **If priming the pump does not eliminate excessive pressure fluctuations, the piston seals or check valves may be dirty or defective**

1. Follow these steps to isolate the cause:
 - a. If leaks are seen from the piston rinse tubes, replace the piston seals (see Section 5.2).
 - b. If no leaks are seen, replace the check valves (see Section 5.1). Impurities in the eluents can cause dirty or defective check valves. Install end line filters (P/N 045987) to help prevent this (see Section 3.1.2).
 - c. Using a 7-mm open-end wrench or your fingers, loosen the lock on the mechanical chassis drawer. The lock is on the lower right side of the chassis, between valves 3 and 4 (see the label on the inside of the lower door). Pull out the mechanical chassis drawer a few inches.
 - d. If a piston does not move when there is pump flow, examine it for breakage and replace if necessary. If a piston moves, examine the pump head for scratches and replace if necessary (see Section 5.3). If a piston moves slightly and then breaks contact with the rocker arm follower, replace the piston seal (see Section 5.2).
 - e. Push the mechanical chassis drawer back in place, making sure the cables are not pinched. Tighten the drawer lock.



Observe the warning label on the inside of the lower door. The arrows on the label indicate moving mechanical parts that present pinch hazards when the pump is on and the mechanical drawer is open. Do not touch any parts within the mechanical chassis while the pump is on.



Respectez l'étiquette d'avertissement apposée à l'intérieur de la porte inférieure. Les flèches sur l'étiquette indiquent des pièces mécaniques mobiles qui posent un danger de pincement lorsque le GP50 est sous tension et le tiroir mécanique est ouvert. N'utilisez jamais le GP50 avec le tiroir du châssis mécanique ouvert.

4.2 Pump Will Not Start

- **Flow rate is set to zero**

Reset the flow rate (see Section 2.4.2).

- **Pump starts briefly during priming, but then stops because of high pressure limit**

Open the pressure transducer waste valve (see Figure B-5) by turning the knob counterclockwise two turns.

4.3 Pump Stops

- **Method or other remote input instructed the pump to stop**

Check the display screen for error messages. If none are displayed, the pump was probably instructed to stop by the method, computer, or other remote signal source.

- **Electrical cables improperly installed**

1. Set the pump to **LOCAL** mode, **DIRECT CONTROL**. Press **Off/On** to start the pump.
2. If a non-zero flow rate is displayed and the keypad LED is on, verify that the electrical cables in the mechanical chassis are properly installed.
 - a. Turn off the GP50 power.
 - b. Using a 7-mm open-end wrench or your fingers, loosen the lock on the mechanical chassis drawer. The lock is on the lower right side of the chassis, between valves 3 and 4 (see the label on the inside of the lower door).
 - c. Pull out the mechanical chassis drawer a few inches.
 - d. Locate the distribution card on the top of the mechanical chassis. Check that all cables are seated correctly in the connectors on the card.
 - e. Push the mechanical chassis drawer back in place, making sure the cables are not pinched. Retighten the drawer lock. Turn on the power.

- **Low pressure limit was tripped. The following message is displayed:**

Low Pressure Limit Violation

1. Verify that eluent is present in the channel selected. If the eluent reservoir is empty, refill it or select a channel which does have eluent. Prime the pump (see Section B.2.8) before resuming operation.
2. Make sure the waste valve on the pressure transducer (see Figure B-5) is closed by turning the knob on the pressure transducer housing clockwise.



Overtightening the pressure transducer waste valve may damage the valve and the pressure transducer housing.

3. Make sure there are no liquid leaks in the flow system.
4. Set the pump to **LOCAL** mode, **DIRECT CONTROL**. Press **Off/On** to start the pump. Verify that the pistons are moving and that you can hear the pump.

If there is no sound from the pump, check the LED on the CPU card inside the door to the electronics chassis. A red LED indicates a defective power supply. To have the power supply (P/N 046440) replaced, contact Dionex Technical Support.

With the pump running, open the **DSP STATUS** screen (press **Menu, 8, 8,** and **3**). and note whether the left-right pressure varies by more than 3% between strokes. If it does, refer to Section 4.1. If it does not, either increase the flow rate or reduce the low pressure limit setting and continue operation.

- **High pressure limit was tripped. The following message is displayed:**

High Pressure Limit Violation

1. Isolate segments of the flow path to determine the source of the high backpressure.
 - a. Remove the pump inlet tubing from the injection valve.
 - b. Turn on the pump and record the backpressure.
 - c. One at a time, add each segment of the remainder of the flow path to determine the source of the backpressure. If reconnecting a component causes a sharp increase in backpressure, preplace the component. Replace tubing, fittings, or components as necessary to resume operation at the standard operating backpressure.
 - d. If the source of the high backpressure is the column, refer to the column manual for cleanup procedures. The column may need replacement.
2. Verify that the pressure transducer is calibrated correctly.
 - a. Open the pressure transducer waste valve (see Figure B-5) by turning the knob counterclockwise about two turns.
 - b. Check the pressure reading; if it is above 97 KPa (14 psi), recalibrate the pressure transducer (see Section C.3.6).

- **A DSP-related error message is displayed**

Several error messages are related to Digital Signal Processor (DSP) errors: *DSP communication fails*, *DSP does not acknowledge*, etc. If one of these messages is displayed, follow the procedure below:

1. Turn off the GP50 power.
2. Verify that the DSP card is present and correctly installed in slot 1 of the electronics chassis (see Figure 2-6).
3. Turn on the GP50 power.

4. If the DSP error message reappears, notify Dionex Technical Support. The power supply (P/N 046440), DSP card (P/N 045369), or CPU card (P/N 046340) may need to be replaced.



Do not remove any of the electronic cards from the pump. There are no user-serviceable components on the cards. If servicing is required, it must be performed by qualified personnel and appropriate electrostatic discharge (ESD) handling procedures must be followed.



Ne retirez aucune des cartes électroniques de la pompe. Aucun des composants sur les cartes ne peut être réparé par l'utilisateur. Toute réparation doit être effectuée par un personnel qualifié utilisant des procédures correctes de décharge électrostatique.

- **The following error message displays:**

Motor Drive Fails

If the pump motor is in a runaway condition, the motor automatically shuts off and the above error message is displayed. Contact Dionex Technical Support.

- **The following error message displays:**

Encoder index not found

1. Turn off the GP50 power.
2. Verify that the cables connected to the DSP card in the electronics chassis (see Figure 2-6) are seated properly.
3. Turn on the GP50 power. If the error message reappears, notify Dionex Technical Support.

4.4 Liquid Leaks/Leak Alarm

- **Leaks from the front rinse ports or rear of the pump head may indicate a defective piston seal**
 1. Replace the piston seal and the rinse seal (see Section 5.2).
 2. Check all connections between the eluent reservoirs and the pump heads. Tighten the fitting connections just enough to stop the leak.
- **Proportioning valve leaks**

Tighten loose fittings. If there are no loose fittings, replace the valve (see Section 5.5).



Overtightening the fitting connections may strip the threads in the valve block. If this happens, replace the entire manifold assembly (P/N 046203).

- **Pressure transducer leaks**

Inspect the pressure transducer. If the waste valve is the source of the leak, replace the waste valve O-ring (see Section 5.4). If the leak is from the rear of the transducer, contact Dionex Technical Support.
- **Priming valve**

Tighten any leaking fittings just enough to stop the leak. If this does not stop the leak, replace the fittings and/or tubing making the connection. If this does not stop the leak, replace the priming block assembly (P/N 054086). Contact Dionex Technical Support.

- **Interior mechanical chassis leaks**

Inspect the chassis for leaks. Tighten any leaking fittings. Replace any damaged parts.

4.5 Noisy Pump Motor

- **DSP (digital signal processing) card current limit has been exceeded. The card includes a built-in current limiter to protect the motor and motor drive.**

Check the three small LEDs in the upper left corner of the DSP card bulkhead, which is in the electronics chassis behind the pump upper door. If the LEDs are flashing in time with the pump strokes, the current limiter is being activated. As the pump motor ages, it becomes less efficient and the current limit is activated more frequently. Activating the current limit is harmless, but if it occurs frequently, even at low speeds and/or pressures, the bottom plate assembly (P/N 045670) needs to be replaced. Call Dionex Technical Support for assistance.

- **Pressure servo oscillation**

Check the **DSP STATUS** screen (press **Menu, 8, 8,** and **3**) to verify that the correct pump head volume and head material are selected. If the settings are correct but the problem persists, notify Dionex.

- **Out of prime**

Reprime the pump (see Section B.2.8).

4.6 Vacuum Degas Pump Does Not Run

- **DEGAS OPTIONS screen settings incorrect**

Go to the **DEGAS OPTIONS** screen (press **Menu** and **4**). If the **DEGAS PUMP** field is set to **ALWAYS OFF**, select **BY SETTING** and then enter the cycle duration and frequency times (see Section C.1.6).

- **Electrical cables improperly installed**

Follow the steps below to manually test the degas pump.

1. Go to the **DEGAS STATUS** screen (press **Menu**, **8**, **8**, and **3**). Press a **Select** button to toggle the **TEST** field to **RUN** and press **Enter**.
2. The pump should turn on and run for the cycle duration time specified in the **DEGAS OPTIONS** screen (2 minutes by default). If it does not run, verify that the cables connected to the pump in the electronics chassis (see Figure 2-6) and in the mechanical chassis are properly connected.

To check the mechanical chassis connections:

- a. Turn off the GP50 power.
- b. Using a 7-mm open-end wrench or your fingers, loosen the lock on the mechanical chassis drawer. The lock is on the lower right side of the chassis, between valves 3 and 4 (see the label on the inside of the lower door). Pull the drawer out a few inches.
- c. Locate the distribution card on the top of the mechanical chassis. Check that all cables are seated correctly in the connectors on the card.
- d. If the connections are correct, the distribution card may need to be replaced. Call Dionex Technical Support.
- e. Push the mechanical chassis drawer back in place, making sure the cables are not pinched. Retighten the drawer lock.

4.7 Vacuum Degas Pump Calibration Fails

At the end of the degas calibration, the **DEGAS READING** value is less than 13000 counts and one of the following error messages appears:

Degas vacuum pump is not present or degas circuitry is malfunctioning.

Vacuum Degas Fails

Verify that the cable to the vacuum degas pump is connected to the distribution card in the mechanical chassis.

1. Turn off the GP50 power.
2. Using a 7-mm open-end wrench or your fingers, loosen the lock on the mechanical chassis drawer. The lock is on the lower right side of the chassis, between valves 3 and 4. Pull out the drawer a few inches.
3. The distribution card is on the top of the mechanical chassis. Labels printed on the card identify the various cables plugged into it. Locate the connector for the vacuum degas pump (labeled **VAC PUMP**) near the right rear corner of the card. Make sure the cable is fully seated in the connector.
4. Push the mechanical chassis drawer back in place, making sure the cables are not pinched. Retighten the drawer lock.
5. Turn on the power.
6. Retry the calibration. If the message reappears, contact Dionex Technical Support.

4.8 Vacuum Degas Pump Low Vacuum

The GP50 monitors the degas vacuum reading every 1 min. If the degas vacuum is lower than the monitoring value, the degas pump turns on. When the pump turns off, if the vacuum reading is 2000 counts or more lower than the monitoring value, the following message displays:

```
LOW VACUUM ALARM!!  
Check DEGAS OPTIONS settings or refer to  
service manual
```

Open the **DEGAS OPTIONS** screen (press **Menu** and **4**). Try increasing the **CYCLE DURATION** time and/or decreasing the **TIME BETWEEN CYCLES**. If this does not resolve the problem, contact Dionex Technical Support.

4.9 Relays or TTLs Inoperative

- **Incorrectly installed cables**

Make sure the cable(s) between the GP50 relay or TTL connector(s) and the connector(s) on the other instrument(s) are connected properly (see Section D.3).

- **Method programming error**

For Local control, make sure the parameter to turn on or off the relay/TTL is set correctly on the **METHOD EXTENSION** screen (see Section C.1.5). For Remote control, make sure the command for turning the relay/TTL on or off is entered correctly into the PeakNet 6 program file or the PeakNet 5 Method.

For TTL inputs, make sure the controlling device is programmed correctly.

- **When attempting to set TTL2, the following message displays:**

```
TTL2 is set to indicate FLOW/NO FLOW.
```

The **TTL2 OUTPUT USAGE** field on the **PUMP OPTIONS** screen is currently set to signal when pump flow stops (**0 FLOW**). This setting is used to control the power to a Self-Regenerating Suppressor® (SRS®). To use TTL2 for another function, open the **PUMP OPTIONS** screen (press **Menu** and **6**) and set the **TTL2 OUTPUT USAGE** field to **NORMAL**.

4.10 Poor Chromatographic Reproducibility

- **Liquid lines incompletely flushed after an eluent change**

Attach a syringe to the priming block valve (see Figure B-5) and draw at least 2.5 mL (20 mL if the vacuum degas pump is installed) of the new eluent through the liquid lines before beginning operation.

- **Leaking piston seal**

Check for liquid leaks at the rinse ports in the front of the pump heads. Replace the piston seal on any head with a leak (see Section 5.2).

- **Malfunctioning proportioning valve**

Test the valves (see Section C.2.7). If a test fails, the proportioning valve assembly may need to be replaced (see Section 5.5).

This chapter describes service and repair procedures that the user may perform. Any procedures not included here, including electronics-related service procedures, must be performed by Dionex personnel. For assistance, contact Dionex Technical Support. In the U.S., call 1-800-346-6390. Outside the U.S., call the nearest Dionex office.

Before replacing any part, refer to the troubleshooting information in Chapter 4 to isolate the cause of the problem.



Substituting non-Dionex parts may impair performance, thereby voiding the product warranty. Refer to the warranty statement in the Dionex Terms and Conditions for more information.



The CPU card contains a lithium battery. If the CPU card is displaced, dispose of the used battery according to the manufacturer's instructions.

5.1 Cleaning and Replacing the Check Valves

A dirty check valve causes erratic flow rates and pressures and may cause the pump to lose prime and/or be difficult to reprime.

1. Turn off the main power switch, to ensure you do not unintentionally start the pump.
2. Disconnect the tube fittings from the inlet and outlet check valve housings (see Figures 5-1 and 5-2).
3. Use a 1/2-inch wrench to loosen both check valve housings. Remove the check valve housings and cartridges from the pump head. Carefully remove the check valve cartridges from the housings.
4. Place the check valve housings and cartridges in a beaker with methanol, and sonicate or agitate for several minutes.

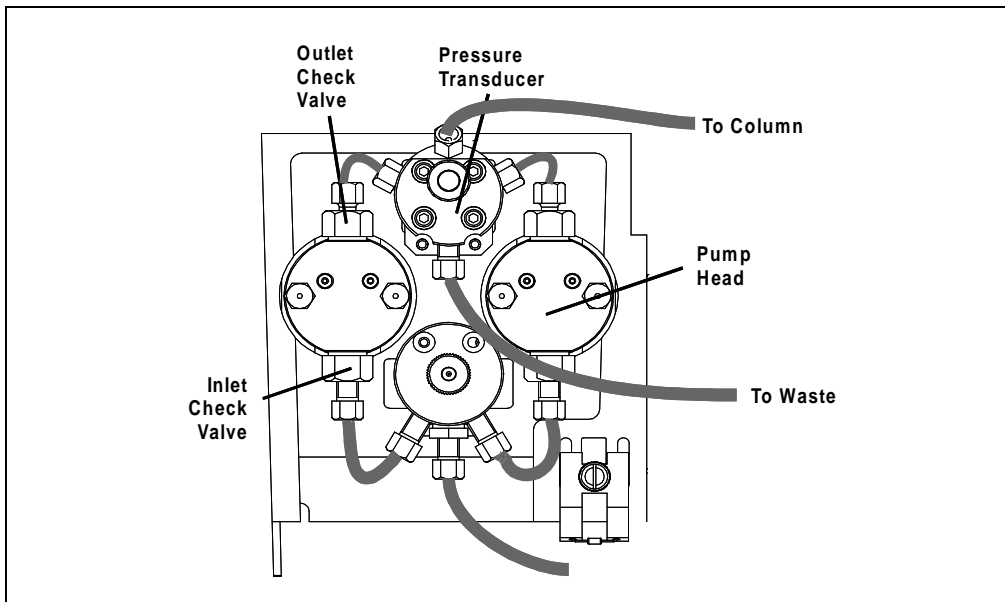

Figure 5-1. Pump Heads and Liquid Lines (PEEK)

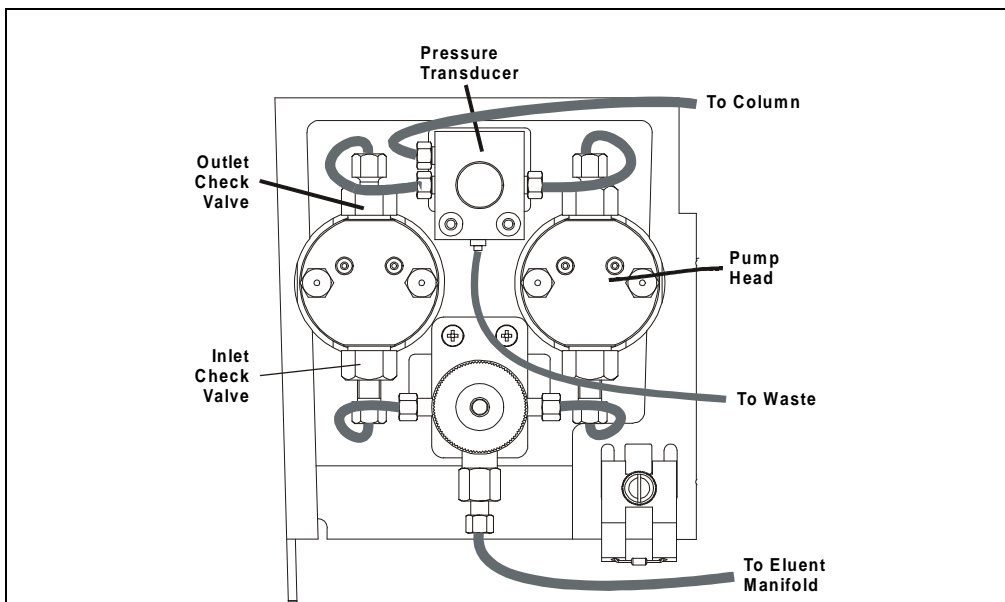

Figure 5-2. Pump Heads and Liquid Lines (SST)

5. Rinse each check valve housing and cartridge thoroughly with filtered deionized water.
6. The *inlet* check valve assembly housing has a 1/4-28 port (PEEK pumps) or a 10-32 port (stainless steel pumps). Replace the cartridge in the inlet check valve housing, making sure the double-hole end of the cartridge is visible.

The *outlet* check valve assembly housing has a 10-32 port (PEEK and stainless steel pumps). Replace the cartridge in the outlet check valve housing, making sure the single-hole end of the cartridge is visible. Liquid flows through the check valve in the large single hole and out the small double holes.

NOTE The pump will not operate properly unless the cartridge is installed in the housing in the correct orientation.

7. Reinstall the check valves. Be sure to install the inlet check valve on the bottom of the head and the outlet check valve on the top of the head. Tighten only enough to seat (25 in-lb. torque). Tighten a little more only if it leaks.



Overtightening may damage the pump head and check valve housing and crush the check valve seats.

8. Reconnect the liquid lines.
9. Turn on the GP50 power.
10. Prime the pump (see Section B.2.8). If the pump will not prime and you have eliminated all other possible causes of the problem, replace the check valve cartridge.

Check Valve Cartridge Type	Part Number
Standard Bore PEEK	047747
Standard Bore Stainless Steel	047755
Microbore PEEK	047748
Microbore Stainless Steel	048279

After replacing the check valve cartridge, go to the **ELAPSED TIME** screen (press **Menu**, **8**, and **2**). Move the cursor to the **VALVES IN USE** field and press **Enter** to reset the field to 0 cycles.

5.2 Piston Seal Replacement

A damaged seal allows leakage past the piston and then through the rinse ports in the front of the pump heads. The pump may be difficult to prime, flow rates will be unstable, and baseline noise may be observed.

1. Turn off the main power switch, to ensure you do not unintentionally start the GP50.
2. Disconnect the tube fittings from the pressure transducer and the inlet check valve (see Figures 5-1 and 5-2).
3. Remove the two nuts from the pump head.
4. Carefully disengage the head from the piston by pulling the head straight off and away from its mounting guides.



Lateral motion while disengaging the head from the piston may break the piston.



Un mouvement latéral pendant la séparation de la tête et du piston peut casser le piston.

5. Place the head (front end down) on a clean work surface and lift off the backup washer to expose the piston guide (see Figures 5-3 and 5-4).
6. The pistons are captured by a magnetic retention system and do not come off as part of the pump head assembly. After removing the pump head, hold the shaft of the piston and apply just enough lateral force to overcome the magnetic field and remove the piston.

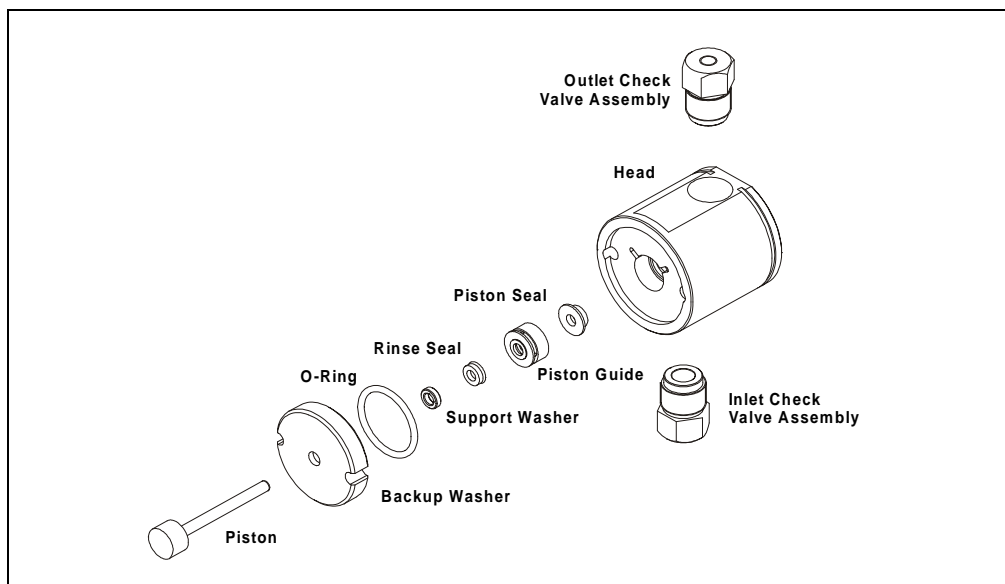

Figure 5-3. Pump Head Assembly

Component	Standard Bore/PEEK	Standard Bore/SST	Microbore/PEEK	Microbore/SST
Pump Head Assembly	054087	054096	054094	054095
Pump Head	054051	054050	054098	054099
Outlet Check Valve	047661	047665	047657	047663
Inlet Check Valve	047660	047665	047656	047663
Piston Seal	054400	054402	054401	054401
Piston Guide	045633	045633	045632	045632
Rinse Seal	048722	048722	048721	048721
Support Washer	050745	050745	050744	050744
O-Ring	014895	014895	014895	014895
Backup Washer	045630	045630	045631	045631
Piston	052840	052840	053584	053584

Table 5-1. Pump Head Assembly Part Numbers

7. To remove the piston guide and seal:
 - a. Fill the head cavity with deionized water by injecting through either the piston opening or the inlet check valve.
 - b. Reinsert the piston approximately 1/8-in into the seal (see Figure 5-4).
 - c. Install a 10-32 fitting plug (P/N 042772) on the outlet check valve. Tighten the plug.
 - d. Push the piston into the head. This should hydraulically unseat the seal and piston guide from the head. Remove the piston and pull off the guide and seal.

NOTE If the piston guide and seal do not come out, make sure the 10-32 plugs are tight. Then, add more water and repeat Steps b and d.

- e. Remove the 10-32 fitting plug.

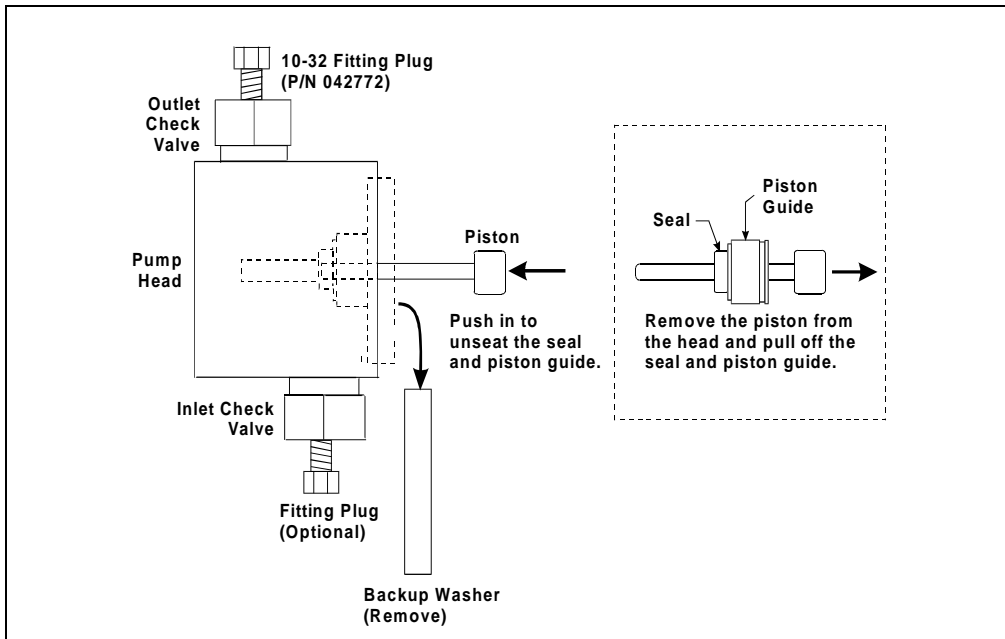

Figure 5-4. Removing the Piston Seal

8. To install the new seal and reinstall the piston guide:
 - a. Push the piston through the piston guide and the new seal. Then, insert the piston, piston guide, and seal into the pump head until the seal contacts the bottom of the counterbore (see Figure 5-5, View A).
 - b. Hold the piston guide and seal in place and remove the piston from the head (see Figure 5-5, View B).
 - c. Seat the seal by pushing the piston guide into the head until it is flush with the head.

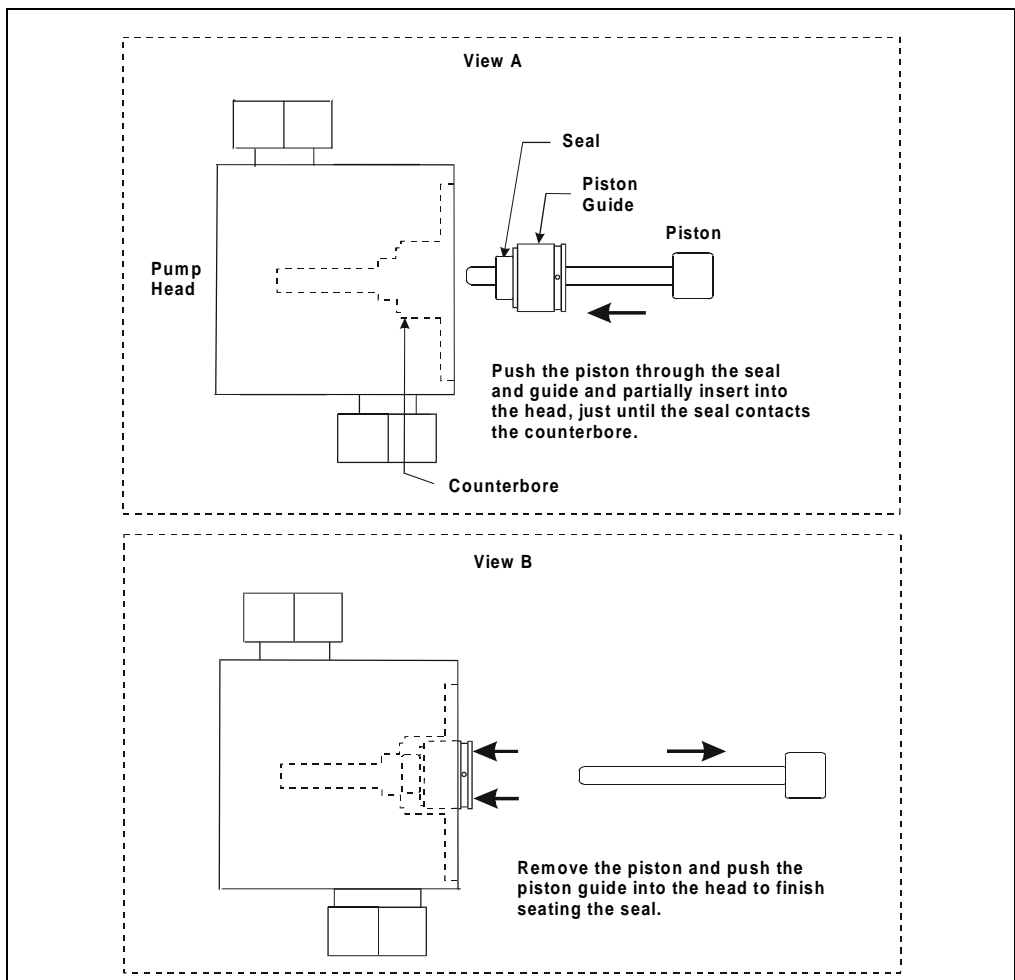

Figure 5-5. Installing the Piston Seal

9. Dionex recommends reinstalling the head and piston as a single assembly so that the piston centers itself. To do this:
 - a. Press the backup washer into the head until it is flush with the indented surface of the head.
 - b. Insert the piston *halfway* into the head. This ensures that the magnet in the follower picks up the piston. (The follower is the cylinder that holds the piston in place as it moves in and out of the pump head assembly.)
 - c. Reinstall the head and piston assembly, using a wrench to tighten the nuts evenly (12 in-lb torque).
10. Reconnect the liquid line to the inlet check valve.
11. Reconnect the tube fittings to the pressure transducer.
12. Turn on the GP50 power.
13. Go to the **ELAPSED TIME** screen (press **Menu**, **8**, and **2**). Press **Enter** to reset the **SEALS IN USE** field to 0 cycles. The pump is ready for normal operation.

5.3 Pump Piston Replacement

Continued leaking through the rinse ports after replacing the piston seal (assuming the head is tight) indicates a dirty, scratched, or broken piston.

1. Turn off the main power switch, to ensure you do not unintentionally start the GP50.
2. Disconnect the tube fittings from the pressure transducer and the inlet check valve (see Figures 5-1 and 5-2).
3. Remove the two acorn nuts from the pump head.



Lateral motion while disengaging the head from the piston may break the piston.



Un mouvement latéral pendant la séparation de la tête et du piston peut casser le piston.

4. Slowly pull the head and allow it to separate from the housing. Carefully disengage the head from the piston by pulling the head straight off and away from the mounting guides.
5. The pistons are captured by a magnetic retention system and do not come off as part of the pump head assembly. After removing the pump head, hold the shaft of the piston and apply just enough lateral force to overcome the magnetic field and remove the piston.
6. Replace the piston and the piston seal. Broken or scratched pistons can damage the piston seal.
7. Dionex recommends reinstalling the head and piston as a single assembly so that the piston centers itself. To do this:
 - a. Press the backup washer into the head until it is flush with the indented surface of the head.
 - b. Insert the piston *halfway* into the head. This ensures that the magnet in the follower picks up the piston. (The follower is the cylinder that holds the piston in place as it moves in and out of the pump head assembly.)
 - c. Reinstall the head and piston assembly, using a wrench to tighten the nuts evenly (12 in-lb torque).
8. Reconnect the liquid line to the inlet check valve.
9. Reconnect the tube fittings to the pressure transducer.
10. Turn on the main power switch and prime the pump (see Section B.2.8).

5.4 Pressure Transducer Waste Valve O-Ring Replacement

A damaged O-ring causes leakage around the base of the pressure transducer waste valve knob.

1. Turn off the main power switch, to ensure you do not unintentionally start the GP50.
2. Remove the valve from the pressure transducer housing by turning the knob counterclockwise until it comes loose from the housing.
3. Remove the O-ring (P/N 046434) (see Figure 5-6).
4. Carefully slide a new O-ring (P/N 046434) over the end of the valve and push it into the groove.
5. Reinstall the valve in the housing, turning the knob clockwise until the valve is seated.



Do not overtighten the waste valve.

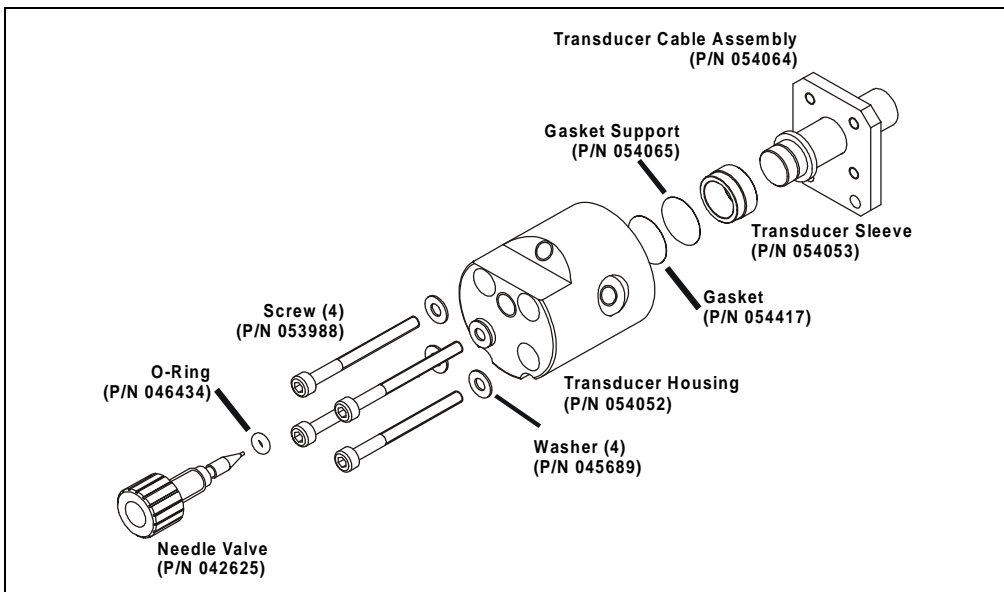

Figure 5-6. Pressure Transducer Assembly

5.5 Proportioning Valve Replacement

A defective proportioning valve can cause the following problems: leaks, nonreproducible eluent compositions (which may cause retention time shifts), and flow restrictions (which may cause high backpressure).

1. Turn off the main power switch, to ensure you do not unintentionally start the GP50.
2. Turn off the pressure on the eluent reservoirs and allow them to vent.
3. Follow these steps to disconnect the proportioning valve electrical connector from the distribution card.
 - a. Using a 7-mm open-end wrench or your fingers, loosen the lock on the mechanical chassis drawer. The lock is on the lower right side of the chassis, between valves 3 and 4 (see the label on the inside of the lower door). Pull out the drawer a few inches.
 - b. The distribution card is on the top of the mechanical chassis. Labels printed on the card identify the various cables plugged into it. Locate the proportioning valve electrical connector, labeled **VALVES**, at the front of the card. Disconnect it from the card.
4. Disconnect the liquid line from the manifold outlet (see Figure 5-7).

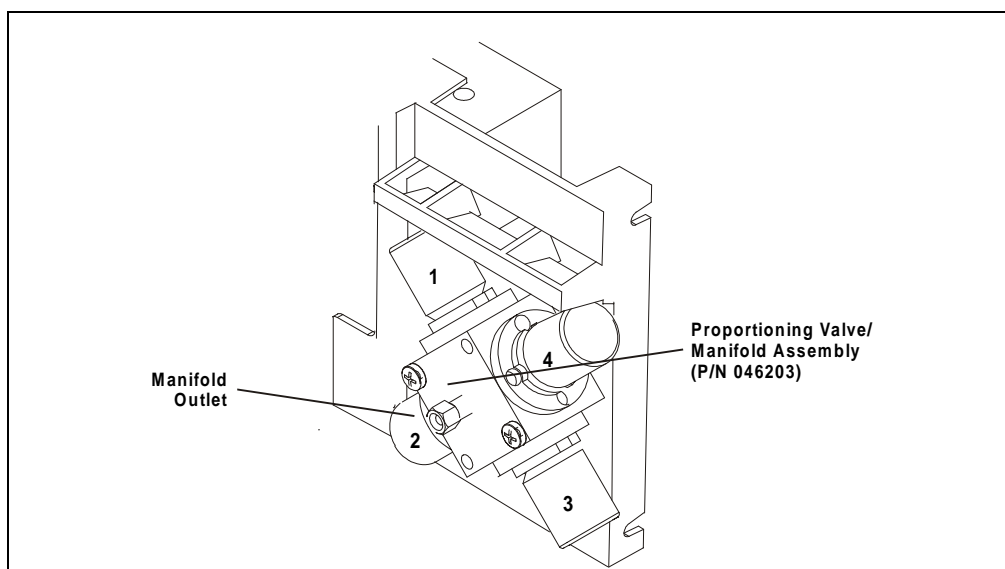

Figure 5-7. Location of Proportioning Valve/Manifold Assembly

5. Loosen the screws securing the proportioning valve/manifold assembly to the bulkhead (see Figure 5-7). Pull the valve/manifold assembly forward and disconnect the eluent lines on the manifold inlet. Remove the valve/manifold assembly completely from the bulkhead.
6. Thread the bundle of electrical lines from the new valve/manifold assembly through the bulkhead and up to the distribution card. Connect the valve electrical connector to the **VALVES** connector on the distribution card.
7. Connect the eluent lines to the new valve/manifold assembly. Make sure eluent lines A through D are in the appropriate valve ports. Connect eluent line A to the valve marked #1, eluent B to the valve marked #2, and so on.



CAUTION

Tighten liquid connections to the valve no more than fingertight plus one-quarter turn. Overtightening or crossthreading the valve fittings may strip the threads in the manifold block. If this happens, replace the valve/manifold assembly.

8. Align the new assembly as shown in Figure 5-7 and mount it to the bulkhead. Tighten the screws.
9. Push the mechanical chassis drawer back in place, making sure the cables are not pinched. Retighten the drawer lock.
10. Attach the liquid line from the priming block to the manifold outlet.
11. To verify that each valve is functioning properly, connect a syringe to the priming valve. One at a time, select 100% of each eluent valve and draw liquid through the valve. After successfully drawing liquid through each valve, turn off the pump.
12. Next, verify that no liquid passes through the valve when the pump is off. Do not turn on the pump. One at a time, select 100% of each eluent. No liquid should flow through the valve.
13. Turn on the main power switch. The pump is ready for normal operation.

5.6 Changing Main Power Fuses

1. Turn off the main power.



HIGH VOLTAGE—Disconnect the main power cord from its source and also from the rear panel of the GP50.



HAUTE TENSION—Débranchez le cordon d'alimentation principal de sa source et du panneau arrière du GP50.

2. The fuse holder is part of the main power receptacle on the rear panel (see Figure 5-8). Note the recessed lock located on each side of the fuse holder. Using a small screwdriver, push each lock toward the center to release it. When both locks are released and the fuse holder pops out slightly, pull the fuse holder straight out of its compartment.
3. Replace the two fuses in the holder with new IEC127 fast-blow fuses rated 3.15 amps (P/N 054745). Dionex recommends always replacing both fuses.
4. Reinsert the fuse holder into its compartment. The fuse holder is keyed to fit only in its proper orientation. Apply enough pressure evenly against the holder to engage the two locks. When both locks are engaged, the holder is flush against the panel.
5. Reconnect the main power cord and turn on the power.

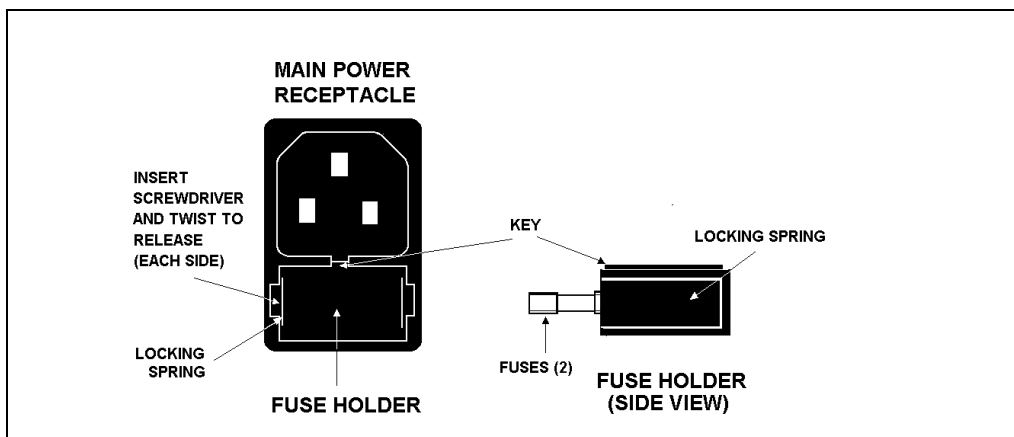

Figure 5-8. Main Power Fuse Holder

A • Specifications

A.1 Electrical

Main Power Requirements	100 Vac to 240 Vac, 50/60 Hz; 2.5 amps. The GP50 power supply is main voltage auto-sensing and requires no manual adjustment.
Fuse Requirements	Two 3.15 amp fast-blow IEC127 fuses (P/N 954745)

A.2 Environmental

Operating Temperature	10 °C to 50 °C (50 °F to 104 °F)
Operating Humidity	5 to 95% relative humidity (non-condensing)

A.3 Physical

Dimensions	33.5 cm high x 22.5 cm wide x 42 cm deep (13.1 in x 8.9 in x 16.8 in) 6 cm (2.5 in) clearance required behind the module
Weight	19 kg (42 lb)
Decibel Level	60 db (“A WEIGHING” setting)

A.4 Display and Keypad

Display	Liquid crystal with adjustable backlighting.
Keypad	26-button pad for entering commands and numeric values for screen parameters.

A.5 Hydraulics

Eluent Selection	Four different eluent components; each can be proportioned from 0 to 100%
Pump	Dual-piston, variable speed, 100 μL (standard bore), 25 μL (microbore) stroke, user-selectable constant pressure or constant flow feedback control
Flow Rate	Standard bore pump head: 0.04 to 10.0 mL/min linearly variable in increments of 0.01 mL/min Microbore pump head: 0.01 to 2.50 mL/min linearly variable in increments of 0.01 mL/min
Operating Pressure	35 MPa (5000 psi) maximum
Pressure Resolution	0.07 MPa (10 psi)
High Pressure Limit	0 to 35 MPa (0 to 5000 psi) in increments of 0.05 MPa (7.25 psi); trips instantaneously
Low Pressure Limit	0. to 35 MPa (0 to 5000 psi) in increments of 0.05 MPa (7.25 psi); trips after a time-out of 0.4 mL for the standard bore GP50 or 0.1 mL for the microbore GP50
Delay Volume (No Mixer)	Standard bore pump head: <700 μL Microbore pump head: <300 μL

A.6 Control

Remote Limited remote operation via TTL-input logic level, and TTL-output and relay contact closures, or full remote programming and control via the DX-LAN interface.

Local (Front Panel) *Methods:* Stores up to 100 separate methods (00 through 99), The actual number of stored methods depends on available memory. Each method may contain up to 50 separate steps.

Storage: Nonvolatile memory protects against the loss of programs during power-down or in the event of a power failure.

A.7 Vacuum Degas Pump Assembly (Optional)

Channels 4-channel membrane vacuum degas

Materials Wetted materials, PEEK, PTFE

B.1 Facility Requirements

- Make sure the GP50 installation site meets the electrical and environmental requirements in Appendix A.
- Install the GP50 on a sturdy workbench at a height that ensures convenient viewing of the front panel display and access to the interior.



Lift the GP50 only from the bottom or side surfaces of the module. Lifting by the front doors will damage the door hinges. Use caution when lifting the module, which weighs 19 kg (42 lb).



Ne soulevez le GP50 que par le fond ou les côtés. Son soulèvement par la porte du panneau avant endommagera les charnières de la porte. Soyez prudent lorsque vous soulevez le GP50: il pèse 19 kg (42 lb).

- Allow at least 6 cm (2.5 in) free space behind the GP50 for connections and ventilation.
- The GP50 Gradient Pump is capable of operation with or without head pressure on the eluent. If pressurization is used, provide a source of helium to pressurize the eluent and regenerant reservoirs (if used).
- House eluents at least 3 cm (8 in) above the pump in an EO1 Eluent Organizer (P/N 044125) or in built-in eluent containment (such as the LC25 Chromatography Oven reservoir container).
- Always filter eluents to remove small particulates that may contaminate the pump. Install an end-line filter (P/N 045987) on the end of each eluent reservoir line. Filters are supplied in the pressurizable reservoir Ship Kits. Refer to the *Pressurizable Reservoir Installation Instructions* for details.
- Dionex strongly recommends degassing eluents. If the vacuum degas assembly is not installed, refer to Section 3.1.1 for manual degassing instructions.

B.2 Installation Instructions

The GP50 Ship Kit contains items necessary for completing the installation.

GP50 Gradient Pump Version	Ship Kit
Standard bore/microbore with PEEK components	P/N 054621
Standard bore/microbore with stainless steel components	P/N 054627

B.2.1 Power Connection



SHOCK HAZARD—To avoid electrical shock, a grounded receptacle must be used. Do not operate or connect to AC power mains without an earthed ground connection.



DANGER D'ÉLECTROCUTION - Pour éviter toute électrocution, il faut utiliser une prise de courant avec prise de terre. Ne l'utilisez pas et ne le branchez pas au secteur C.A. sans utiliser de branchement mis à la terre.



The power supply cord is used as the main disconnect device. Make sure the socket-outlet is located near the GP50 and is easily accessible.



Le cordon d'alimentation principal est utilisé comme dispositif principal de débranchement. Veillez à ce que la prise de base soit située/installée près du module et facilement accessible.



Operation at AC input levels outside of the specified operating voltage range may damage the GP50.

The GP50 power supply is auto-sensing, so no adjustment is required to select the line voltage. There are two ways to control power to the GP50.

- Control from the GP50

To implement: Connect a modular power cord (IEC 320 C13) from the GP50 main power receptacle (see Figure B-1) to a grounded, single-phase power source. Use the GP50 power switch to turn the pump power on and off.

- Control from the LC30 Chromatography Oven

To implement: Locate one of the IEC jumper cables (P/N 960748) provided in the LC30 Ship Kit. Connect the jumper cable from the GP50 main power receptacle to an IEC auxiliary receptacle on the LC30 rear panel. Leave the GP50 power switch on continuously and use the LC30 main power switch to turn the pump power on and off.

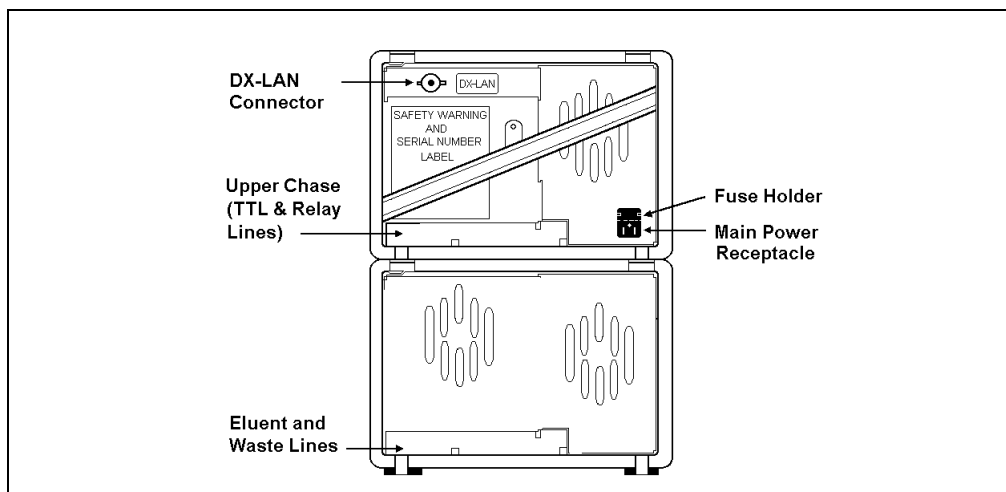

Figure B-1. GP50 Rear Panel

B.2.2 Electronics Chassis Connections

The electronics chassis connections vary, depending on which chromatography module is installed with the pump. Refer to the appropriate section below.

LC10 or LC20 Connections

1. Route the leak sensor cable from the rear of the LC10 Chromatography Organizer or the LC20 Chromatography Enclosure through the GP50 upper phase (see Figure B-1). Connect the cable to the **LC LEAK** connector in slot 1 of the pump electronics chassis (see Figure B-2).
2. Route the solenoid valve cable from the rear of the LC10 or LC20 through the GP50 upper phase. Connect the cable to the **LC AIR** connector in slot 1 of the pump electronics chassis (see Figure B-2).

NOTE Refer to Appendix D for TTL and relay installation instructions.

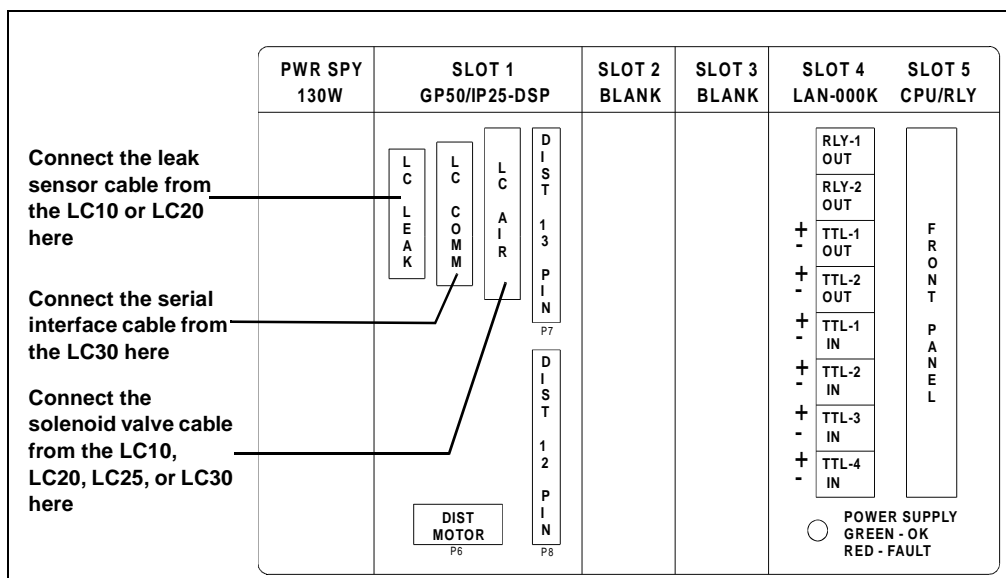

Figure B-2. GP50 Electronics Chassis
(Located behind pump upper door)

LC25 Connections

Route the electronics injection valve cable from the rear of the LC25 Chromatography Oven through the GP50 upper chase (see Figure B-1). Connect the cable to the **LC AIR** connector in slot 1 of the pump electronics chassis (see Figure B-2).

NOTE Do not connect the LC25 to the LC LEAK connector in slot 1; the oven contains internal leak control electronics.

LC30 Connections

1. Route the RJ-11 serial cable from the rear of the LC30 Chromatography Oven through the GP50 upper chase (see Figure B-1). Connect the cable to the **LC COMM** connector in slot 1 of the pump electronics chassis (see Figure B-2).
2. Route the solenoid valve cable from the rear of the LC30 through the GP50 upper chase. Connect the cable to the **LC AIR** connector in slot 1 (see Figure B-2).

NOTE Do not connect the LC30 to the LC LEAK connector in slot 1; the oven contains internal leak control electronics.

B.2.3 DX-LAN Interface: 10BASE-T Connections (Optional)

NOTE Check the DX-LAN connector on the GP50 rear panel. If a 10BASE-T RJ-45 (telephone-style) connector is installed, follow the instructions in Section B.2.3. However, if a BNC connector is installed, follow the instructions in Section B.2.4.

In order to communicate with a host computer running Dionex chromatography software, the GP50 must contain a pump interface card (P/N 056800) and an unshielded twisted-pair 10BASE-T DX-LAN cable (P/N 960281) must be connected from the 10BASE-T RJ-45 connector on the rear panel to a “combo” 10BASE-T Ethernet hub (P/N 056909).

Installing or Replacing the Pump Interface Card

NOTE If the DX-LAN option was not installed at the factory, order the pump interface card kit (P/N 057005). The kit includes all the components required for DX-LAN communication.



STATIC—The GP50 electronics cannot be serviced by the user. The pump interface card must be installed by qualified personnel. Standard anti-static procedures must be observed when installing the interface card or handling the CPU card.



To prevent damage to the GP50, turn off the main power before installing the pump interface card. After confirming that the LED on the CPU card is off (not green or red), unplug the power. Do not rely on the front panel power switch.



Pour éviter d'endommager le GP50, coupez l'alimentation électrique principale avant d'installer la carte interface du pompe. Après avoir confirmé que la DEL de la carte d'unité central est éteinte (ni verte ni rouge), débranchez le courant. Ne vous fiez pas à la position de l'interrupteur d'alimentation du panneau avant.

1. To replace an existing pump interface card, remove the DX-LAN cable from the 10BASE-T DX-LAN connector on the GP50 rear panel (see Figure B-1).
2. Remove any TTL/Relay plugs from the connectors at slot 4 of the electronics chassis (see Figure B-2).
3. Disconnect the 60-pin ribbon cable from the inside of the front panel by opening the ejector latches on the connector.
4. Using a screwdriver as a lever, open the white ejector latch at the bottom of the CPU card. Remove the CPU card, cable, and Relay card as a single unit.
5. Remove the pump interface card (if present) from slot 4 of the electronics chassis.
6. Insert the new pump interface card (P/N 056800) into slot 4:
 - a. Slide the card to the rear.
 - b. Verify that the 10BASE-T connector is aligned with the opening at the rear and that the card is aligned with the card connector.
 - c. Press firmly on the card until it mates fully with the connector on the rear panel. Pull on the card to verify that it cannot move.
7. Reinstall the CPU/Relay card. Press firmly until the card is inserted into the connector on the rear panel.
8. Reconnect the ribbon cable to the 60-pin connector on the inside of the front panel. The header and connector are key-polarized near the center. The ejector latches should be partially open to accept the cable connector.
9. Install the 10BASE-T DX-LAN cable (see the following section).

Installing the 10BASE-T DX-LAN Cable

1. Install the “combo” 10BASE-T Ethernet hub (P/N 056909) on a workbench or on the wall. For installation instructions and site requirements, refer to the installation guide shipped with the hub.
2. Plug the 10BASE-T DX-LAN cable (P/N 960281) into a 10BASE-T port on the front panel of the hub.

IMPORTANT

The 10BASE-T DX-LAN cable is a Category 5 unshielded twisted-pair cable. Do not substitute a cable of an inferior grade. Failure to use the correct cable will cause the pump to lose communication with the host computer.

3. Connect the other end of the cable to the 10BASE-T DX-LAN connector on the GP50 rear panel (see Figure B-1).
4. Connect a 10BASE-T cable (P/N 960281) from a 10BASE-T port on the hub to the 10BASE-T port on the host computer’s internal DX-LAN card. If the connection is via port 8 on the hub, set the Normal/Uplink push button to Normal.

NOTE For installation instructions for the host computer’s internal DX-LAN card, see *Installing the Dionex PeakNet 6 System* (Document No. 031631) or *Installing the Dionex PeakNet System* (Document No. 034941).

IMPORTANT

When using 10BASE-T cabling, you must install a hub. If you simply plug the 10BASE-T cable from the pump into the connector on the host computer’s DX-LAN card, the connection will either not work or will be unreliable.

Network Upgrades

If you upgrade the network from a BNC connector to a 10BASE-T connector, turn off the computer power briefly and then turn it on again to allow the host computer’s internal Ethernet DX-LAN card to detect the 10BASE-T connector. The Ethernet card searches for the type of installed cabling only at power-up.

Cascading Hubs

Cascading, or connecting hubs together through their 10BASE-T ports, increases the number of ports or the number of users supported on the network. For instructions, refer to the installation guide for the hub.

B.2.4 DX-LAN Interface: BNC Connections (Optional)

NOTE Check the DX-LAN connector on the GP50 rear panel. If a BNC connector is installed, follow the instructions in Section B.2.4. However, if a 10BASE-T RJ-45 (telephone-style) connector is installed, follow the instructions in Section B.2.3.

In order to communicate with a host computer running Dionex chromatography software, the GP50 must contain a pump interface card (P/N 046341) and a coaxial DX-LAN cable (P/N 960405) must be connected to the BNC tee connector (P/N 921914) on the rear panel. From the GP50, connect the DX-LAN cable to:

- Another instrument equipped with a BNC connector, *or*
- A “combo” 10BASE-T Ethernet hub (P/N 056909). The hub has one BNC port and eight 10BASE-T RJ-45 ports.

Installing or Replacing the Pump Interface Card

NOTE If the DX-LAN option was not installed at the factory, order the pump interface card kit (P/N 044195). The kit includes the components required for DX-LAN communication.

IMPORTANT

STATIC—The GP50 electronics cannot be serviced by the user. The pump interface card must be installed by qualified personnel. Standard anti-static procedures must be observed when installing the interface card or handling the CPU card.



To prevent damage to the GP50, turn off the main power before installing the pump interface card. After confirming that the LED on the CPU card is off (not green or red), unplug the power. Do not rely on the front panel power switch.



Pour éviter d'endommager le GP50, coupez l'alimentation électrique principale avant d'installer la carte interface du pompe. Après avoir confirmé que la DEL de la carte d'unité central est éteinte (ni verte ni rouge), débranchez le courant. Ne vous fiez pas à la position de l'interrupteur d'alimentation du panneau avant.

1. To replace an existing pump interface card, remove the hex nut securing the BNC DX-LAN connector to the GP50 rear panel (see Figure B-1).
2. Remove any TTL/Relay plugs from the connectors at slot 4 of the electronics chassis (see Figure B-2).
3. Disconnect the 60-pin ribbon cable from the inside of the front panel by opening the ejector latches on the connector.
4. Using a screwdriver as a lever, open the white ejector latch at the bottom of the CPU card. Remove the CPU card, cable, and Relay card as a single unit.
5. Remove the pump interface card (if present) from slot 4 of the electronics chassis.
6. Insert the new pump interface card (P/N 046341) into slot 4:
 - a. Slide the card to the rear.
 - b. Verify that the BNC connector is aligned with the opening at the rear and that the card is aligned with the card connector.
 - c. Press firmly on the card until it mates fully with the connector on the rear panel. Pull on the card to verify that it cannot move.
7. Reinstall the CPU/Relay card. Press firmly until the card is inserted into the connector on the rear panel.
8. Reconnect the ribbon cable to the 60-pin connector on the inside of the front panel. The header and connector are key-polarized near the

center. The ejector latches must be partially open to accept the cable connector.

9. Install the hex nut, BNC tee connector, and coaxial DX-LAN cable (see the following section).

Installing the BNC Tee Connector and Coaxial DX-LAN Cable

1. Install the BNC tee connector (P/N 921914):
 - a. Note the two small locking pins on either side of the BNC DX-LAN connector on the rear panel (see Figure B-1).
 - b. Push the tee connector onto the BNC connector on the rear panel and twist until the locking pins are fully engaged in the slots on the tee connector.
 - c. Pull firmly on the tee connector to verify that it cannot move.
2. Install the coaxial DX-LAN cable (P/N 960405):
 - a. Push the metal sleeve on the end of the DX-LAN cable onto one port of the BNC tee connector.
 - b. Twist the metal sleeve until the locking pins on the tee are fully engaged in the slots on the cable's metal sleeve.
 - c. Pull the end of the cable to verify that it cannot move.

IMPORTANT

The DX-LAN cable (P/N 960405) is a 50 ohm coaxial impedance cable. (Fifty ohm cables are imprinted with "RG-58U.") Do not substitute cables. Failure to use the correct cable or to lock it into place on the BNC connector will cause the pump to lose communication with the host computer.

3. If the pump is the last module in the network to be connected, install a 50 ohm terminator resistor plug (P/N 921034) on the remaining port of the BNC tee connector. (These terminator resistor plugs are shipped with Dionex chromatography software.)

If the pump is not the last module in the network, connect the cable from the next module to the BNC tee.

4. Plug the free end of the coaxial DX-LAN cable into one of these:
 - The BNC connector on another instrument, *or*
 - The BNC port on the rear panel of the “combo” 10BASE-T Ethernet hub (P/N 056909).

If the connection terminates at the hub, install a BNC terminator (included with the hub) on the BNC tee connector.

IMPORTANT

A 50 ohm terminator resistor plug must be installed at each end of the BNC DX-LAN network. Before beginning operation, verify that both ends of the DX-LAN have terminator resistor plugs installed.

B.2.5 Waste Lines

The GP50 requires two waste lines; one line from the pressure transducer assembly and one from the leak drain. These lines are factory-installed and routed to the rear panel.

Place the free end of both waste lines into a single waste container. Position the waste container below the level of the GP50 to maintain a positive siphon (see Figure B-3).

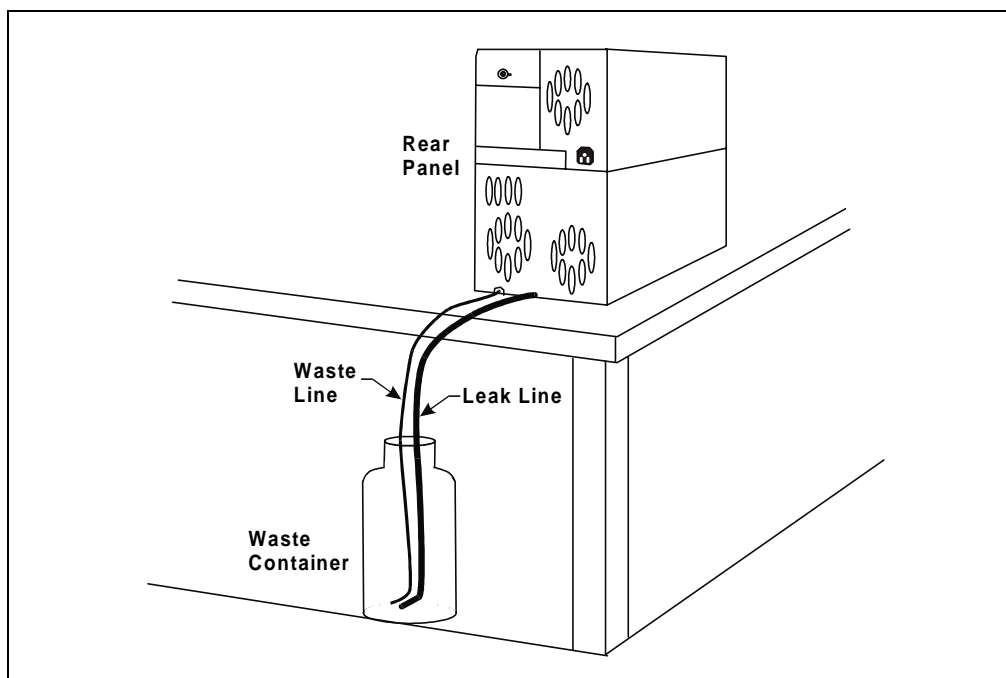

Figure B-3. Eluent Waste Lines

B.2.6 Eluent Inlet Line Connections

Eluent lines A through D are plumbed to the pump at the factory. To complete the installation, attach the free end of each line to the corresponding eluent reservoir.

B.2.7 Eluent Outlet Line Connections

Connect the eluent line exiting the pressure transducer (see Figure 5-1) to the gradient mixer. Connect the tubing exiting the gradient mixer to the injection valve.

B.2.8 Piston Seal Wash Connections (Optional)

NOTE To install the piston seal wash, order the piston seal wash kit (P/N 059187). Follow the instructions below (or the duplicate instructions provided in the kit) to set up the seal wash.

1. Fill a wash bottle with deionized water and place the bottle above the GP50. (During operation, gravity maintains flow through the pump heads.)
2. Cut the clear 1.5-mm (0.06-in) ID tubing (P/N 055847) into three unequal pieces of the following lengths:
 - 115 cm (46 in)
 - 150 cm (60 in)
 - 15 cm (6 in)
3. Install barbed fittings (P/N 037431) on the pump heads as shown in Figure B-4 and push the pieces of clear 1.5-mm (0.06-in) ID tubing onto the barbed fittings.
4. Place the free end of the 115-cm (46-in) piece of tubing into the wash bottle. Make sure the end of the tubing is near the bottom of the bottle.
5. Slide a 10 mL syringe (P/N 054578) over the free end of the 150-cm (60-in) piece of tubing (the waste line). Draw out all of the air to start the liquid flow through the pump heads. Remove the syringe.
6. Push the piece of black 0.25-mm (0.01-in) ID PEEK tubing (P/N 057057) into the waste line until the PEEK tubing is inserted about 5 cm (2 in) into the waste line tubing.
7. Place the waste line in a waste container.

NOTE Assuming a height difference of about 30 inches between the wash bottle and the waste container, the setup described here provides a flow of one drop of liquid every 10 to 12 seconds.

GP50 Gradient Pump

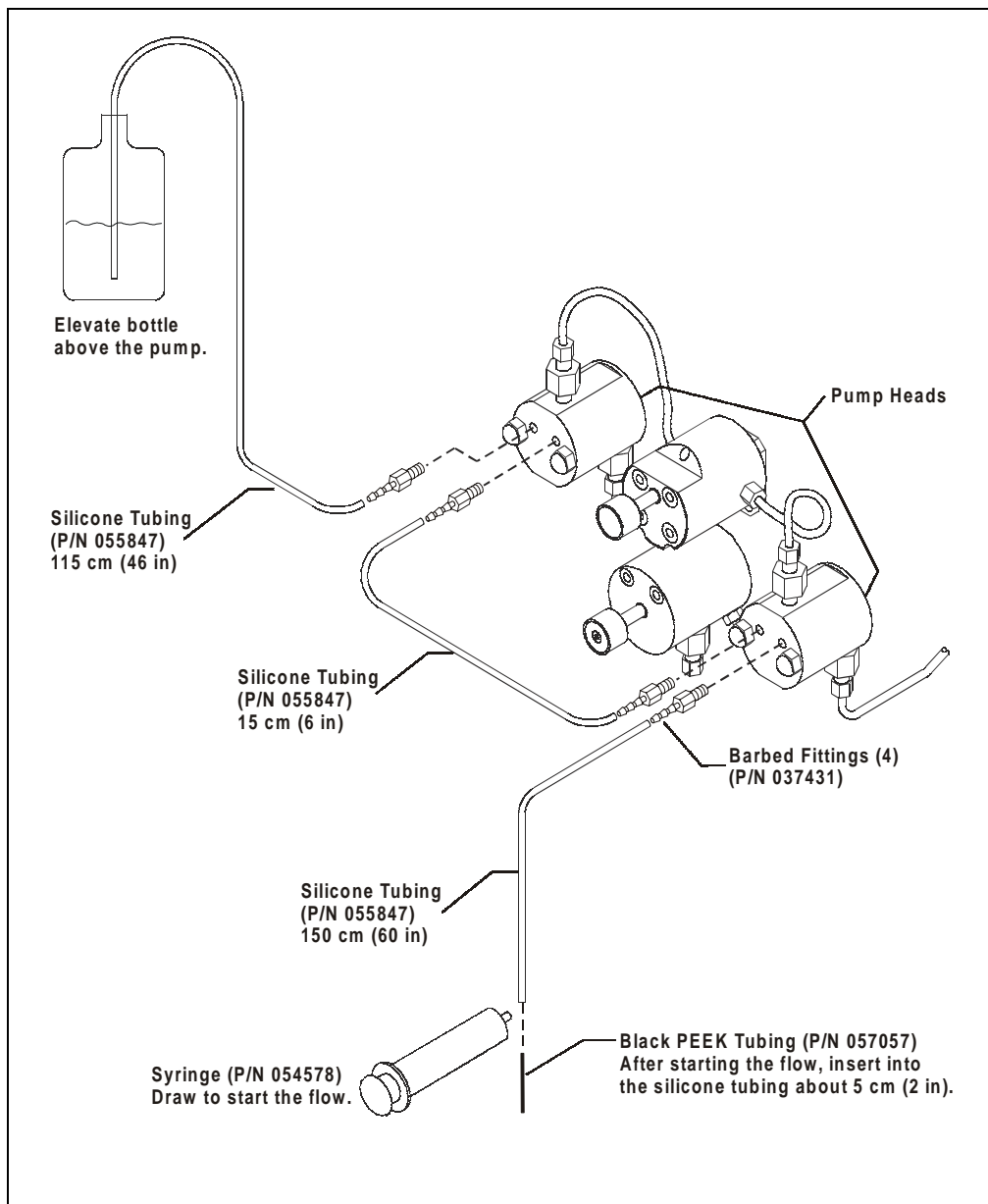

Figure B-4. Piston Seal Wash Connections

B.2.9 Priming the Pump

This section describes three priming procedures. The first two, *Priming with a Syringe* and *Priming with the PRIME Button*, are standard procedures. If these are ineffective, try the third procedure, *Priming with Isopropyl Alcohol*.

Priming with a Syringe

NOTE Priming with a syringe is recommended after changing eluents, or when eluent lines are empty.

1. Press **MENU** and **Enter** to go to the **MAIN** screen. Check that the operating fields are set to **LOCAL** and **DIRECT CNTRL**. If **REMOTE** or **METHOD** is currently set, move the cursor to the appropriate field, press **Select** Δ or **Select** ∇ to toggle the value, and press **Enter** or a cursor arrow button.
2. Move the cursor to the desired eluent. Enter 100 and press **Enter** or a cursor arrow button. This selects 100% of the eluent and automatically sets other eluents to 0%.
3. Connect a 10 mL syringe (P/N 054578) to the luer port in the priming block (see Figure B-5).

NOTE If the eluent is pressurized, liquid will flow into the syringe as soon as you open the priming block valve in the next step. Do not pressurize above 55 KPa (8 psi).

4. Turn the priming block valve counterclockwise about two turns.
5. Press **Off/On** to turn on the pump motor.
6. If the eluent is not pressurized, make sure there is a vent from the eluent bottle or loosen the bottle caps.
7. Draw the syringe back to pull eluent through the flow path. It may take several syringe draws to remove all air or previous eluents from the tubing.

NOTE If the GP50 includes a vacuum degas assembly, draw an additional 17 mL of eluent through the priming block.

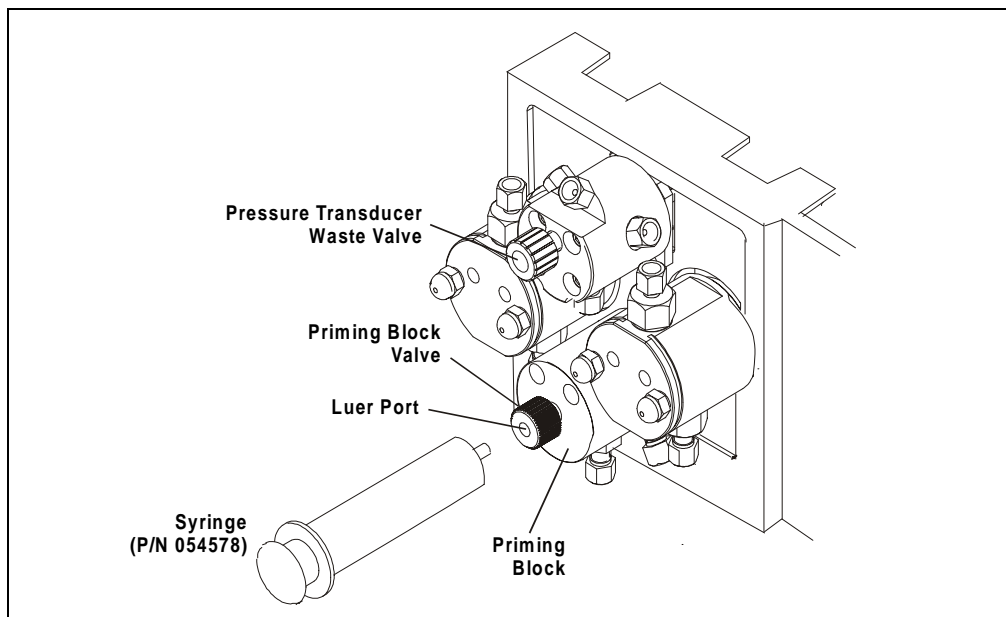

Figure B-5. Priming the Pump

8. Return to Step 2. Select another eluent and repeat the priming procedure.
9. When the manifold has been primed with each eluent, turn the priming block valve counterclockwise until closed (see Figure B-5). **Do not overtighten.**
10. Press **Off/On** to turn off the pump motor. The pump is now ready for operation.

Priming with the Prime Button

1. Go to the **MAIN** screen and select **DIRECT CNTRL** and **LOCAL**.
2. Set the eluent percentage of the line being primed to 100%. Press **Enter** or a cursor arrow button.
3. Open the pressure transducer waste valve one to two turns counterclockwise. This will direct the eluent flow path to waste and eliminate backpressure.

4. Press **Prime** on the GP50 front panel. The pump will pump at 9.9 mL/min for a standard bore pump and 2.5 mL/min for a microbore pump.

NOTE The vacuum degas assembly contains 17 mL of eluent. If this option is installed, allow several extra minutes of prime time to purge air and previous eluent from the degas assembly.

5. Allow the pump to prime until all air and previous eluents are purged and no air bubbles can be seen exiting the waste line. If the eluent manifold has not been primed, allow several extra minutes for the eluent to pass through the pump.
6. Press **Prime** again to return to the flow rate selected for the analysis.
7. Close the pressure transducer waste valve. The pump is now ready for operation.

Priming the Pump Heads with Isopropyl Alcohol

NOTE Prime the pump heads with isopropyl alcohol only if the two standard procedures described previously are unsuccessful.

1. Connect a 10 mL syringe (P/N 054578) filled with isopropyl alcohol to the luer port in the priming block valve (see Figure B-5).
2. Open the pressure transducer waste valve (see Figure B-5) by turning the knob counterclockwise about two turns.
3. Turn the priming block valve counterclockwise about two turns (see Figure B-5).
4. Turn on the pump.
5. Use the syringe to slowly push alcohol through the pump. Avoid pushing any air trapped in the syringe through the pump. Verify that alcohol with no trapped bubbles is traveling down the waste line from the transducer.
6. Close the priming block valve. Do not overtighten. Disconnect the syringe from the priming block. The pressure transducer waste valve should remain open.

7. Press **Prime** to purge the alcohol from the pump heads and flush the heads with the desired eluent.



Isopropyl alcohol may damage some columns. Be sure to thoroughly rinse the alcohol from the pump, using the process described in Step 7.

8. Close the pressure transducer waste valve.
9. Set the desired flow rate. The pump is now ready for operation.

B.3 Automatic SRS Power Control (Optional)

TTL connections can be used to automatically switch off the power to a Self-Regenerating Suppressor (SRS) when the GP50 flow stops. In this setup, the GP50 sends a TTL signal to the detector and then, after a 5-minute delay, the detector shuts off the SRS power. The 5-minute delay allows momentary flow interruptions without disturbing the SRS.

1. Go to the GP50 **PUMP OPTIONS** screen and set **TTL2 OUTPUT USAGE** to **0 FLOW** (see Figure B-6).

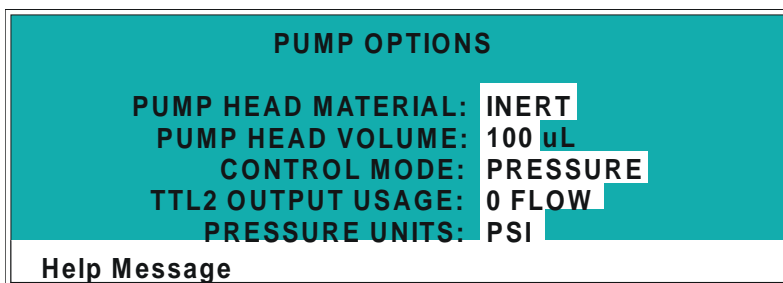
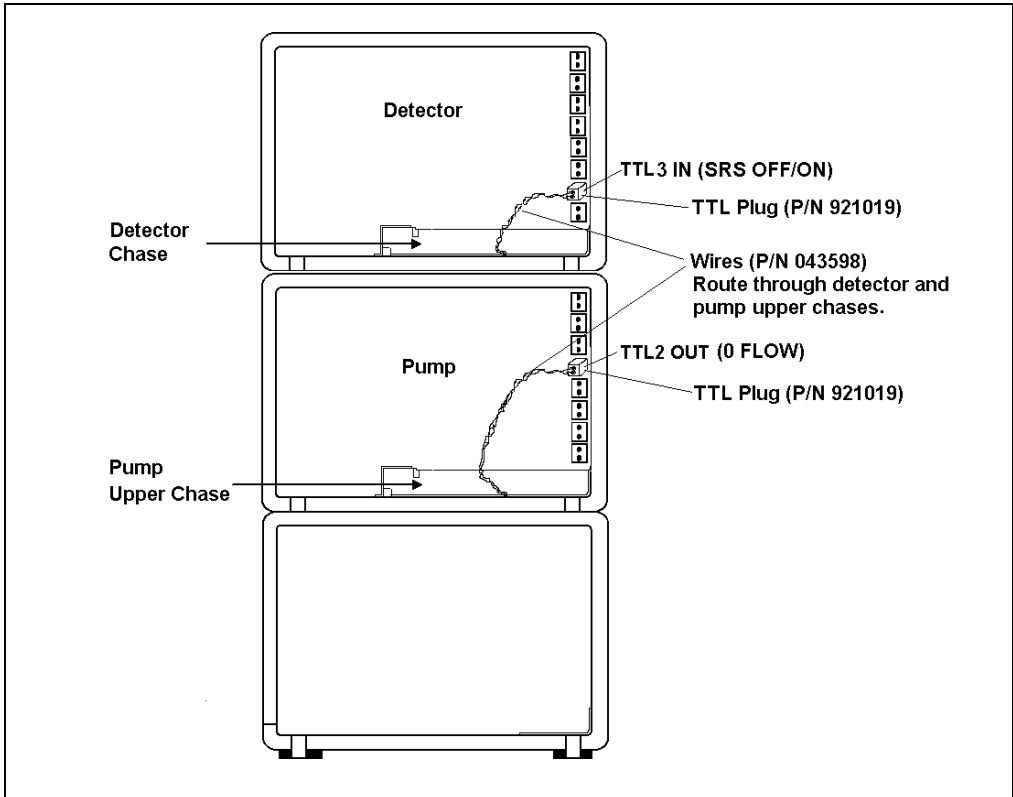

Figure B-6. Pump Options Screen

2. Go to the detector **TTL FUNCTION IN** screen and assign TTL3 to **SRS OFF/ON**.
3. Locate a pair of twisted black and red wires (P/N 043598) and two green TTL connector plugs (P/N 921019) in the GP50 Ship Kit.
4. Insert the wires into the plugs. The signal wire (red) goes on top and the ground wire (black) goes on the bottom of each plug.
5. Plug one end of the cable into **TTL2 OUT** on the GP50. (The TTL connectors are located behind the upper door.) Route the cable through the upper chase of

the GP50 and into the detector upper chase. Plug the other end of the cable into **TTL3 IN** on the detector (see Figure B-7), maintaining the wire orientation described in Step 4.



*Figure B-7. TTL Connections for SRS Power Control
(Detector and pump front views without front doors)*

C • Display Screens

This appendix illustrates and describes all of the screens that can be displayed on the GP50 front panel. There are three types of screens: operational, diagnostic, and calibration (see Figure C-1).

- *Operational* screens allow you to select default pump operating parameters, and to create, edit, and run methods that use timed events to control pump operation.
- *Diagnostic* screens provide access to diagnostic information and tests.
- *Calibration* screens allow you to calibrate pump functions (flow rate, pressure offset, etc.).

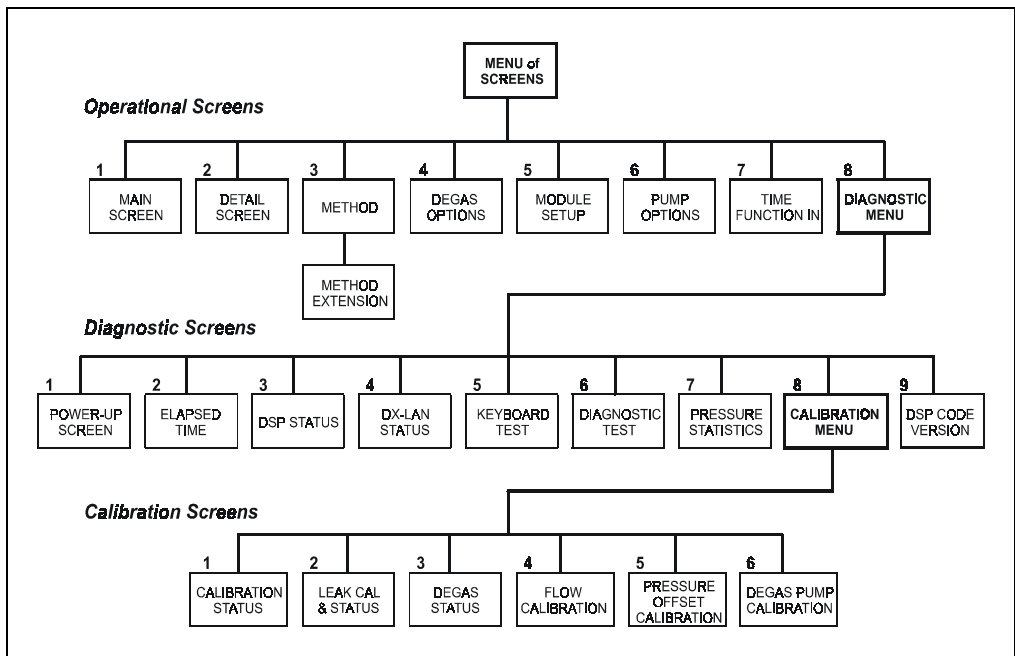

Figure C-1. GP50 Menu Structure

C.1 Operational Screens

C.1.1 Menu of Screens

The **MENU of SCREENS** provides top-level access to GP50 display screens.

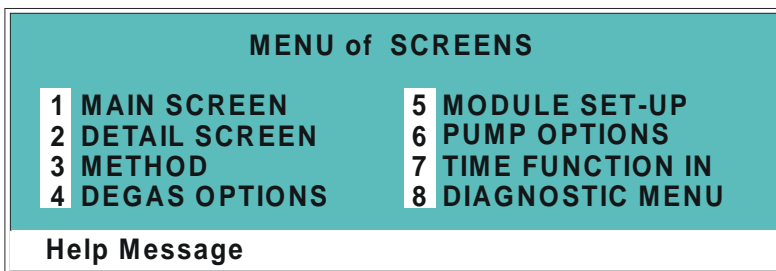

Figure C-2. Menu of Screens

There are two ways to select a screen from a menu:

- Press the numeric button on the front panel keypad that corresponds to the screen number on the menu. For example, press 3 to display the **METHOD** screen.
- Move the cursor to the field containing the screen number and press **Enter**.

To display a brief description of each screen, press **Help**.

C.1.2 Main Screen

The **MAIN** screen displays automatically after power-up. Use the **MAIN** screen to:

- Select the operating mode and control mode.
- Select basic operating parameters for Direct control mode or display the status of operating parameters when a Method is running.
- Select the method number to run.

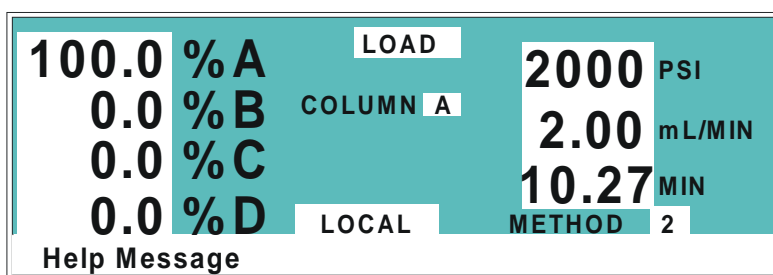

Figure C-3. Main Screen

%A, %B, %C, %D	Displays the percentage of each eluent currently in use. When using Direct control, set the percentage in these fields. These fields will be programmed in the METHOD screen when using Method control.
LOAD/INJECT	Selects the position of the injection valve. The choices are INJECT and LOAD .
PSI (MPa, BAR)	Displays the the system backpressure in psi, MPa, or bar. Set the unit of measure on the PUMP OPTIONS screen (see Section C.1.8).
COLUMN	Selects the active column (A or B) in the chromatography module. Column B is available only when a column switching valve is installed.
mL/MIN	Displays the eluent flow rate through the pump in milliliters per minute. In Direct control, set the flow rate in this field. In Method control, program the flow rate on the METHOD screen (see Section C.1.4).

MIN

Displays the total elapsed time that the method clock has been running. The value can be changed. When you enter a new elapsed time, the method settings corresponding to the new time go into effect.

LOCAL/ REMOTE/ LOCKED RMT

Selects the operating mode:

- Local mode is used to control GP50 operation from the front panel.
- Remote mode is used when PeakNet 5 is running the GP50.
- Locked Remote mode is always used when PeakNet 6 is running the GP50 and is an option when PeakNet 5 is running the GP50. In this mode, operation from the front panel is disabled.

To change to Local mode, use one of the following methods:

- From PeakNet 6, clear the Connect check box on the PeakNet 6 control panel.
- From PeakNet 5, clear the Locked Remote Start option in the Run program.
- Turn off the GP50 power and turn it on again.

DIRECT CONTROL/ METHOD

Selects the control mode:

- Direct control is used to execute operating commands immediately.
- Method control is used to run a programmed series of timed events. Enter the method number to run in the field.

C.1.3 Detail Screen

The **DETAIL** screen provides the information contained in the **MAIN** screen (see Section C.1.2), as well as the additional parameters described below. Use the **DETAIL** screen to:

- Display detailed information about the status of GP50 operating parameters.
- Set parameters for Direct Control operation.

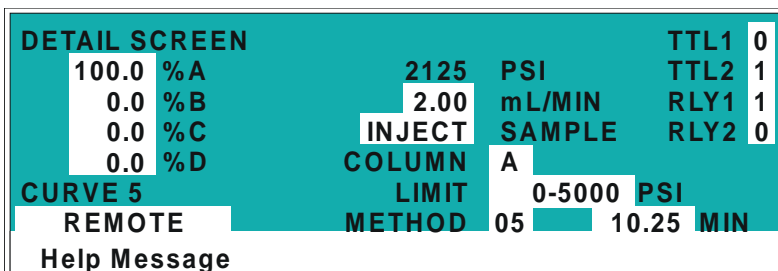

Figure C-4. Detail Screen

- TTL1** Provides TTL and relay control of other devices. In Direct control, select **1** (on) or **0** (off). In Method control, program the TTL and relay fields from the **METHOD** screen (see Section C.1.4). Appendix D describes TTL and relay control.
- TTL2**
- RLY1**
- RLY2**
- CURVE** Indicates the gradient curve selected in the current method step. Refer to Section 2.9.4 for details about the curve types.
- LIMIT** Selects the low pressure and high pressure limits in psi, MPa, or bar. See Section 3.1.5 for guidelines for selecting pressure limits.

C.1.4 Method Screen

Use the **METHOD** screen to select, edit, and save methods.

METHOD EDIT 05		SAVE TO 06		RUN 10	
		LIMITs		0 - 5000 PSI	
TIME	%A	%B	%C	%D	C V FLOW
INIT	25.0	25.0	25.0	25.0	0 L 1.00 >
0.00	100.0	0.0	0.0	0.0	I >
123.45	10.0	22.2	32.3	35.5	5 L 2.00 >
345.67	17.2	19.6	33.2	30.0	>
Help Message					

Figure C-5. Method Screen

NOTE In the %A, %B, %C, %D, C, V and FLOW fields, a “blank” field indicates that the parameter for the previous step remains in effect.

METHOD EDIT	The method number (0 through 99) to edit.
SAVE TO	The method number (0 through 99) to save the current method to.
RUN	The method number (0 through 99) to run. Entering a method number in this field does not affect the status of the method clock. The Hold/Run button on the front panel keypad controls the clock.
LIMITS	The low and high pressure limits in psi, MPa, or bar. See Section 3.1.5 for guidelines for selecting pressure limits. Select the unit of measure from the PUMP OPTIONS screen (see Section C.1.8).
TIME	The elapsed time for each method step. Every method must begin with the INIT (initial) step, followed by the TIME = 0.00 step. Each additional entry under TIME indicates the elapsed time at which the specified conditions (eluent percentages, curve number, flow rate, etc.) occur.

%A, %B, %C, %D	The percentage of each eluent occurring at the start of the step. The total of all eluents must equal 100%.
C	<p>The gradient curve type (0 through 9) to use when moving from the previous step to the current step. See Section 2.9.4 for an explanation of the curve types.</p> <p>Because there are no previous steps for INIT or TIME = 0.0, you cannot enter curve numbers for these steps.</p>
V	The position of the injection valve, either I (inject) or L (load).
FLOW	The flow rate through the pump in milliliters-per-minute.
v	The symbol v next to the bottom time entry indicates there are additional steps below the last step in the screen. Move the cursor to the bottom time entry and press the down arrow to see the additional step(s).
^	The symbol ^ next to the top time entry indicates there are additional steps above the top line. Move the cursor to the top time entry and press the up arrow to see the additional steps(s).
>	The symbol > at the right edge of each line indicates a lateral extension to the line. Move the cursor to the end of a line and press the right arrow to display the METHOD extension screen (see Section C.1.5).

C.1.5 Method Extension Screen

NOTE The **METHOD** extension screen can be accessed only from the **METHOD** screen (see Section C.1.4). To return to the **METHOD** screen, move the cursor to the left edge of the screen and press the left arrow.

Use the **METHOD** extension screen to select the active column and the TTL/relay output parameters for each step in the method.

METHOD EDIT		05	SAVE TO		06	RUN		10
COL		TTL1	TTL2	RLY1	RLY2	TIME		
<	A	0	1	1	0	INIT		
<	B	1		0		0.00		
<			0			123.45		
<	A			1	1	v	345.67	

Help Message

Figure C-6. Method Extension Screen

NOTE The **METHOD EDIT**, **SAVE TO**, and **RUN** fields are the same as in the **METHOD** screen.

- COL (Column)** Selects the active column (**A** or **B**) in the chromatography module. Column B is available only when a column switching valve is installed.

- TTL1** Provides TTL and relay control of other devices.
- TTL2** Select **1** (on) or **0** (off). Appendix D describes TTL and relay control.
- RLY1**
- RLY2**

C.1.6 Degas Options

Use the **DEGAS OPTIONS** screen to set the duration and frequency of the vacuum degas pump cycles.

DEGAS OPTIONS		DEFAULT
DEGAS PUMP:	BY SETTING	
START-UP DURATION:	2 MIN	2 MIN
CYCLE DURATION:	30 SEC	30 SEC
TIME BETWEEN CYCLES:	10 MIN	10 MIN
Help Message		

Figure C-7. Degas Options Screen

DEGAS PUMP

Specifies how the vacuum degas pump operates:

- **BY SETTING:** The degas pump runs according to the options selected from this screen.
- **MONITOR:** The GP50 monitors the degas vacuum reading every one minute. If the reading falls 500 counts below the calibration threshold value, the degas pump turns on and runs for the cycle duration time.
- **ALWAYS OFF:** The pump is always off.
- **ALWAYS ON:** The pump is always on. This setting is reserved for test purposes by Dionex Service Representatives.

START-UP DURATION

The length of time the pump runs at power-up (2-5 min).

CYCLE DURATION

The length of time the pump runs during each cycle (0-120 sec).

TIME BETWEEN CYCLES

The time to wait between cycles (1-99 min).

NOTE The **DEGAS PUMP CALIBRATION** screen displays the degas threshold value (see Section C.3.7).

GP50 Gradient Pump

The GP50 monitors the degas vacuum reading every one minute. If the degas vacuum reading is at or below the alarm threshold value (2000 counts below the calibration threshold value), the following message displays:

LOW VACUUM ALARM!!
Check DEGAS OPTIONS settings or refer to
service manual

If this occurs, increase the **CYCLE DURATION** time and/or decrease the **TIME BETWEEN CYCLES**. If adjusting these settings does not solve the problem, contact Dionex Technical Support.

C.1.7 Module Setup

Use this screen to adjust the display backlight, and to toggle the key actuation and error tones on or off. Adjustments made in this screen will be the default until new adjustments are made.

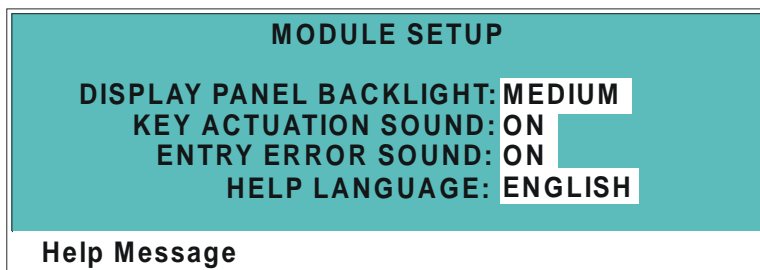

Figure C-8. Module Setup Screen

DISPLAY PANEL BACKLIGHT	Sets the backlight to LOW , MEDIUM , HIGH , or OFF .
KEY ACTUATION SOUND	Toggles the key actuation sound ON or OFF .
ENTRY ERROR SOUND	Toggles the error entry sound ON or OFF .
HELP LANGUAGE	Selects the language (English or Japanese) for Help and error messages.

NOTE If no keypad buttons are pressed within a two-hour period, the backlight will automatically turn off. Press any button to restore the backlight.

C.1.8 Pump Options

Use the **PUMP OPTIONS** screen to specify the type of pump head installed and to set pump operation parameters.

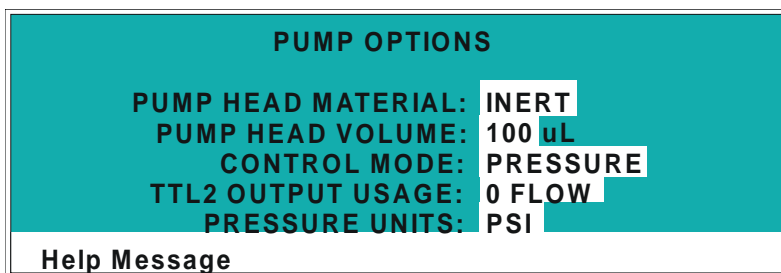

Figure C-9. Pump Options Screen

PUMP HEAD MATERIAL	Select INERT for PEEK pump heads or SST for stainless steel pump heads.
PUMP HEAD VOLUME	Select 100 μL for standard bore pump heads or 25 μL for microbore pump heads.
CONTROL MODE	Sets the pump flow control mode: <ul style="list-style-type: none">• PRESSURE mode uses pressure as the primary source of feedback to maintain flow rate stability.• FLOW mode uses motor speed as the primary source of feedback to maintain flow rate stability.
TTL2 OUTPUT USAGE	Sets the active state of the TTL2 output signal. <ul style="list-style-type: none">• Select 0 FLOW to automatically switch off the power to a Self-Regenerating Suppressor when the pump flow stops. To implement this feature, TTL2 out on the pump must be connected to TTL3 in on the detector. For detailed instructions, see Section B.3.• Select NORMAL to activate TTL2 as a standard TTL output.
PRESSURE UNITS	Sets the unit of measure for pressure (PSI , MPa , or BAR).

C.1.9 Time Function In

Use the **TIME FUNCTION IN** screen to:

- Select a TTL input signal mode.
- Display the pump functions that can be controlled via TTL input from another device.

See Appendix D for details about TTL-controlled functions and connections.

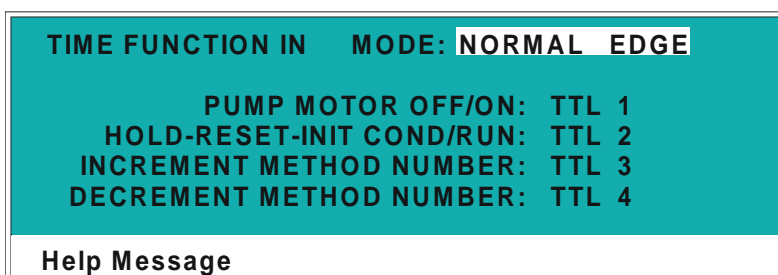

Figure C-10. Pump Options Screen

MODE

Select the signal mode (**NORMAL EDGE**, **INVERTED EDGE**, **NORMAL PULSE**, or **INVERTED PULSE**) that corresponds to the signal type of the controlling device. The default mode, normal edge, is compatible with the TTL output signals provided by Dionex modules.

C.2 Diagnostic Screens

C.2.1 Diagnostic Menu

The **DIAGNOSTIC MENU** lists the available diagnostic screens. To go to the menu, select option **8** from the **MENU of SCREENS**.

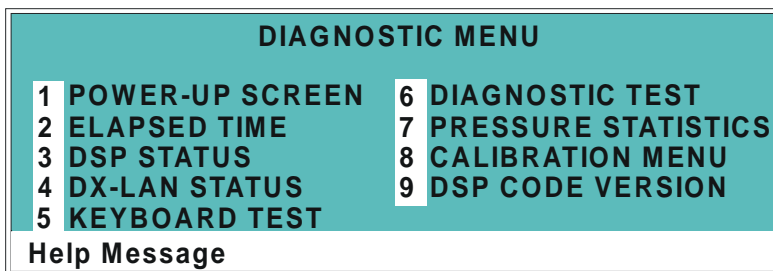

Figure C-11. Diagnostic Menu

There are two ways to select a screen from the menu:

- Press the numeric button on the GP50 front panel keypad that corresponds to the screen number on the menu. For example, press **8** to select and display the **CALIBRATION MENU**.
- Move the cursor to the field containing the screen number and press **Enter**.

To display a brief description of each screen, press **Help**.

C.2.2 Power-Up Screen

Use the **POWER-UP** screen to check the volume of the pump head installed, the revision levels of the Moduleware and BIOS installed, and the ID number of the DX-LAN interface (if connected).

The **POWER-UP** screen is automatically displayed when the GP50 power is turned on.

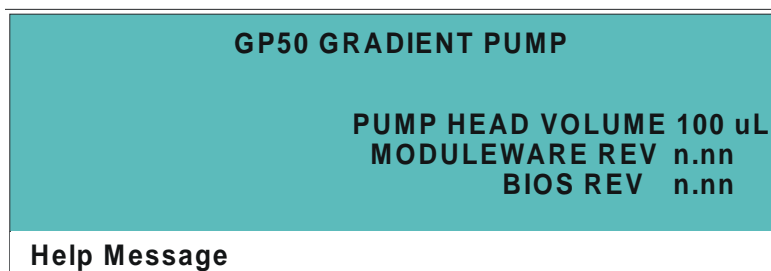

Figure C-12. Power-Up Screen

C.2.3 Elapsed Time

Use the **ELAPSED TIME** screen to check for how long various GP50 components have been in use. The status of each parameter updates in real time.

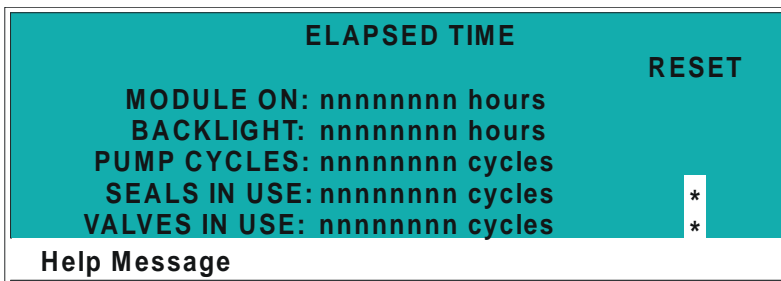

Figure C-13. Elapsed Time Screen

MODULE ON	Reports the total time the module has been powered up in its lifetime.
BACKLIGHT	Reports the total time the display backlight has been on in its lifetime.
PUMP CYCLES	Reports the total cumulative number of pump cycles during the life of the motor. This field automatically resets to 0 after the pump motor is replaced.
SEALS IN USE	Reports the total number of pump cycles since the last time the seals were replaced. Reset this field to 0 when the seals are replaced.
VALVES IN USE	Reports the total number of pump cycles since the last time the check valves were serviced. Reset this field to 0 when the valves are serviced.
RESET	Resets the SEALS IN USE or VALVES IN USE counter to 0. Move the cursor to the corresponding asterisk (*) field and press Enter . Always reset the seals and valves counters to 0 when they are replaced or serviced.

C.2.4 DSP Status

Use the **DSP STATUS** screen to check the status of DSP (digital signal processor) dynamic parameters. Status updates are in real time.

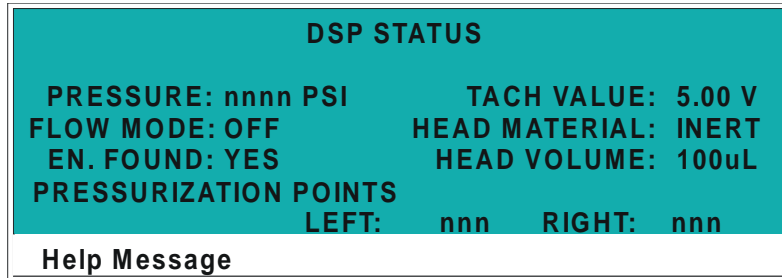

Figure C-14. DSP Status Screen

PRESSURE	Reports the current head pressure in psi, MPa, or bar.
TACH VALUE	Reports the current motor tachometer reading in volts.
FLOW MODE	Reports the flow mode as ON or OFF : ON = System is in constant flow mode. OFF = System is in pressure feedback mode.
HEAD MATERIAL	Reports the head material specified on the PUMP OPTIONS screen (see Section C.1.8): INERT = PEEK heads METAL = stainless steel heads
EN. FOUND	Reports whether the encoder is found.
HEAD VOLUME	Reports the head volume specified on the PUMP OPTIONS screen. The options are 100 μ L for standard bore heads or 25 μ L for microbore heads.
PRESSURIZATION POINTS	Reports the current pressurization point for the left and right pistons. The pressurization points are the points at which the pump speed is adjusted at each stroke to maintain a constant flow rate.

C.2.5 DX-LAN Status

Use the **DX-LAN STATUS** screen to monitor several types of errors that may occur on the network.

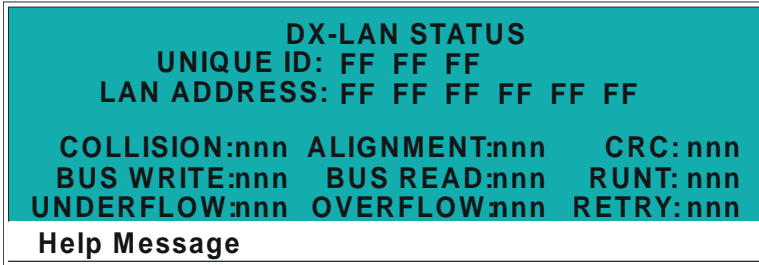

Figure C-15. DX-LAN Status Screen

UNIQUE DX-LAN ID	Displays the three-byte DX-LAN ID programmed in the Moduleware (in HEX).
DX-LAN ADDRESS	Displays the six-byte DX-LAN address assigned by the PC (in HEX). The first three bytes are the system assignment and the last three bytes are the assignment within the system.
COLLISION	Indicates that 16 unsuccessful transmissions of the same packet occurred, due to collisions.
BUS WRITE	Indicates that a ready response could not be issued within 2.4 microseconds after the WR signal was asserted. This occurs when the transmit buffer memory is full.
UNDERFLOW	Indicates that data from the transmit section of the hardware buffer memory is not available for serial transmission. The DX-LAN will continue to send out this data frame.
ALIGNMENT	Indicates that a packet was received with an alignment error, meaning that there were one to seven extra bits at the end of the packet. This is usually caused by a collision or a faulty transceiver.

BUS READ	Indicates that a ready response could not be issued within 2.4 microseconds after the ready signal was asserted. This occurs when reading an empty buffer.
OVERFLOW	Indicates that the DX-LAN hardware receive buffer became full and had to reject a packet for lack of space.
CRC	Indicates that a packet was received with a CRC error. This usually means that a collision has corrupted the packet.
RUNT	Indicates that a “runt” packet (one less than 15 bytes in length) was received. This usually occurs after a collision has truncated the original length.
RETRY	Indicates the number of retries required to transmit the last packet.

C.2.6 Keyboard Test

Use the **KEYBOARD TEST** screen to conduct an interactive test of the front panel keypad buttons.

OFF/ON	RUN/HOLD	UP	7	8	9
		LEFT	RIGHT		
PRIME	RESET	DOWN	4	5	6
INSERT	SEL UP		1	2	3
		HELP	MENU		
DELETE	SEL DOWN		0	.	E
Help Message					

Figure C-16. Keyboard Test Screen

To test the buttons:

1. Press a button on the keypad. Its display changes to reverse video, confirming proper operation of that button.
2. Continue pressing all buttons in turn. Only the most recently pressed button shows in reverse video.
3. To end the test and return to the **DIAGNOSTIC MENU**, press **Menu** twice.

C.2.7 Diagnostic Test

Use the **DIAGNOSTIC TEST** screen to test the GP50 electronics.

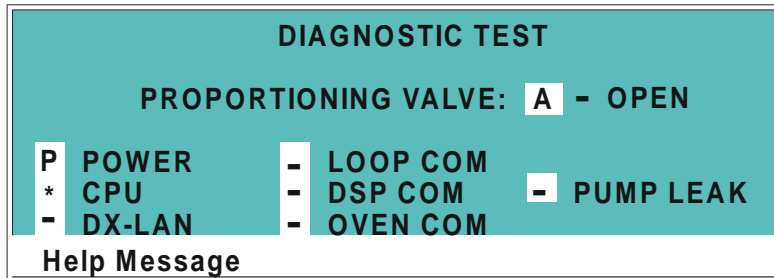

Figure C-17. Diagnostic Test Screen

At power-up, some of these tests are run automatically. If any tests fail, additional tests may be run after the **DIAGNOSTIC TEST** screen is displayed. If errors occur, a message screen displays. When you clear the message, the **DIAGNOSTIC TEST** screen reappears. It remains open until you press the **Menu** button.

PROPORTION- ING VALVE

Selects a valve and displays its status (**OPEN** or **CLOSED**). When the screen opens, valve A is selected and the status field is blank.

To test a valve, first turn off the pump motor. Then, press **Select** Δ or **Select** ∇ to select the desired valve, and press **Enter**. The valve opens.

Thereafter, pressing **Enter** toggles the valve closed and open. Pressing **Delete** followed by **Enter** also closes the valve.

Exiting the **DIAGNOSTIC TEST** screen when the pump motor is off closes all valves.

To manually run a test, position the cursor in the edit field next to the test name, press **Select** Δ or **Select** ∇ to select the asterisk (*), and press **Enter**. The table below explains the test status indicators.

Character	Test Status
-	Test did not run
>	Test is in progress
P	Test passed
F	Test failed

POWER	Checks the +5, ± 15 , and +24 volt monitor on the relay board.
CPU	Checks the CPU internal configuration and the Moduleware checksum.
DX-LAN	Checks the DX-LAN hardware configuration and loop back.
LOOP COM	Checks the LC30 Chromatography Oven communication hardware. A “loop-back” cable must be plugged into the oven communication port. The pump then runs a loop-back test on the port.
DSP COM	Checks communication between the pump CPU and the DSP (Digital Signal Processor) hardware by sending a command and waiting for the appropriate response.
PUMP LEAK	Checks the pump's leak sensor for a correct, open circuit, or short circuit condition.
EXTERNAL LEAK	Checks the external leak sensor for a correct, open circuit, or short circuit condition.

NOTE Exiting the **DIAGNOSTIC TEST** screen clears the pass/fail indicators from the edit fields.

C.2.8 Pressure Statistics

Use the **PRESSURE STATISTICS** screen to view statistical data about the pressure transducer. The values are updated while the screen is displayed.

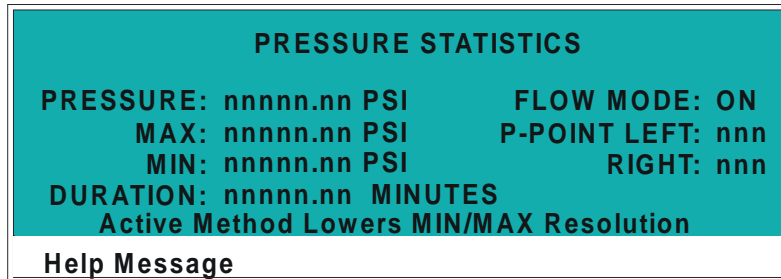

Figure C-18. Pressure Statistics Screen

If a method is running when you go to the **PRESSURE STATISTICS** screen, the following message is displayed:

```
Active Method Lowers MIN/MAX Resolution
```

For more accurate readings, abort the method, go to the **MAIN** screen and select Direct Control mode (see Section C.1.2). Then, re-open the **PRESSURE STATISTICS** screen.

PRESSURE	The measured pressure from the pressure transducer.
MAX	The maximum pressure value during the duration of the test.
MIN	The minimum pressure value during the duration of the test.
DURATION	The duration of the test. The test starts upon entering this screen and terminates upon exiting by pressing the Menu button. To restart the test, press Reset ; the duration is set to 0 and all status values are set to the current pressure.
FLOW MODE	Reports the flow mode as ON or OFF . ON = System is in constant flow mode. OFF = System is in pressure feedback mode.
P-POINT LEFT RIGHT	Reports the current pressurization point for the left and right pistons. The GP50 updates the readout once per piston stroke.

C.2.9 DSP Code Version

Use the **DSP CODE VERSION** screen to view the current DSP (digital signal processor) code revision numbers.

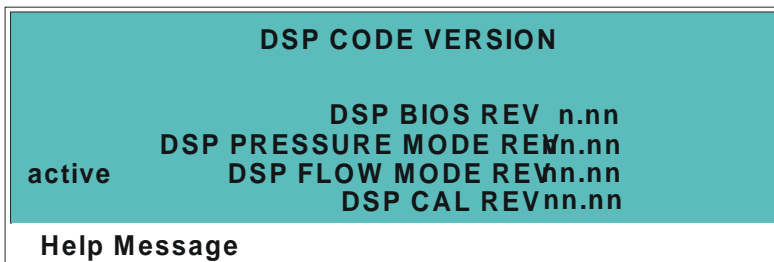

Figure C-19. DSP Code Version Screen

C.3 Calibration Screens

C.3.1 Calibration Menu

To go to the **CALIBRATION MENU**, select option **8** from the **DIAGNOSTIC MENU**.



Figure C-20. Calibration Menu Screen

There are two ways to select a screen from the menu:

- Press the numeric button on the GP50 front panel keypad that corresponds to the screen number on the menu. For example, press 4 to select and display the **FLOW CALIBRATION** screen.
- Move the cursor to the field containing the screen number and press **Enter**.

To display a brief description of each screen, press **Help**.

C.3.2 Calibration Status

Use the **CALIBRATION STATUS** screen to check the status of calibration parameters in real time.

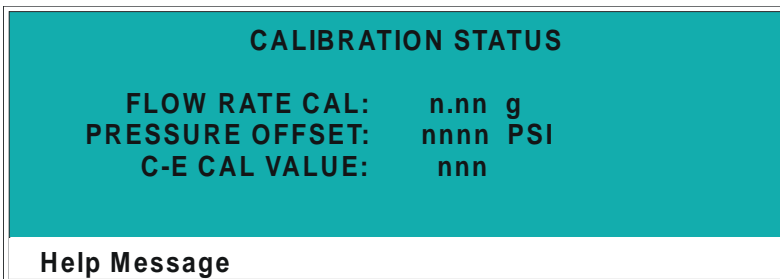

Figure C-21. Calibration Status Screen

FLOW RATE CAL	The current flow rate calibration value.
PRESSURE OFFSET	The pressure offset calibration value as reported by the DSP (digital signal processor).
C-E CAL VALUE	The current binary value for cam-encoder calibration as reported by the DSP.

C.3.3 Leak Sensor Calibration and Status

Use the **LEAK SENSOR CALIBRATION AND STATUS** screen to check the status of leak sensor parameters and to calibrate the sensor.

- The **PUMP** column displays the status of the pump's internal leak sensor.
- The **EXTERNAL** column displays the status of the leak sensor in the chromatography module. If no chromatography module is attached to the pump, the **EXTERNAL** fields display **NONE**.

LEAK SENSOR CALIBRATION AND STATUS		
	PUMP	EXTERNAL
MEASURED VALUE:	2.48	2.75
CURRENT CONDITION:	WET	DRY
CALIBRATION VALUE:	2.50	2.60
LOW LEAK THRESHOLD:	2.70	2.50

Help Message

Figure C-22. Leak Sensor Calibration and Status

MEASURED VALUE

The current measured voltage from the sensor.

CURRENT CONDITION

The current condition of the leak sensor: dry, wet, or err (error). The error condition indicates an open or short circuit.

To calibrate the sensor, press a **Select** button to select **CAL** and press **Enter**. The current measured value becomes the new dry calibration value.

CALIBRATION VALUE

The value saved when the sensor was last calibrated.

LOW LEAK THRESHOLD

The minimum voltage reading that will be accepted as indicating the leak sensor is dry; a reading below this voltage indicates that the sensor is wet. The threshold value is based on the calibration value.

C.3.4 Degas Status

Use the **DEGAS STATUS** screen to check the status of the optional vacuum degas pump calibration parameters in real time and to test the degas pump.

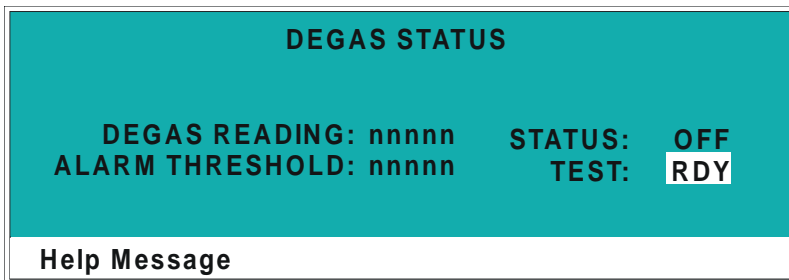

Figure C-23. Degas Status Screen

DEGAS READING	The ADC reading from the degas pump pressure transducer.
STATUS	Reports whether the degas pump is on or off.
ALARM THRESHOLD	A degas reading value below this threshold value triggers the degas pump failure alarm.
TEST	Select RUN and press Enter to test the degas pump. The pump turns on and runs for 2 minutes. While the pump is running, the STATUS field indicates ON . Note: There may be a delay of several seconds before the on/off status is updated.

C.3.5 Flow Calibration

Use the **FLOW CALIBRATION** screen to calibrate the pump.

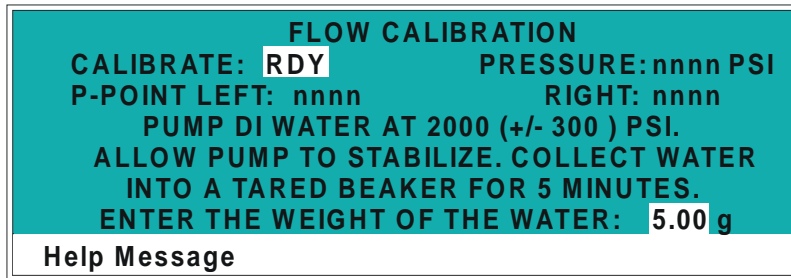

Figure C-24. Flow Calibration Screen

CALIBRATE

To calibrate the flow, select **CAL** and press **Enter**. The pump will use standard calibration parameters for pump control. When **RDY** is selected, the pump uses stored parameters from the last calibration.

After selecting **CAL**, follow the instructions on the screen for calibration. The time required for calibration varies, depending on the pump head volume: 5 minutes for standard bore heads and 20 minutes for microbore heads.

PRESSURE

Displays the measured value from the pressure transducer. Select the pressure unit from the **PUMP OPTIONS** screen (see Section C.1.8).

P-POINT LEFT RIGHT

Displays the pressurization points for the left and right pump pistons.

WEIGHT OF THE WATER

After following the instructions for calibration, enter the measured weight of the water pumped into the beaker.

C.3.6 Pressure Calibration

Use the **PRESSURE CALIBRATION** screen to calibrate the pump pressure offset and slope.

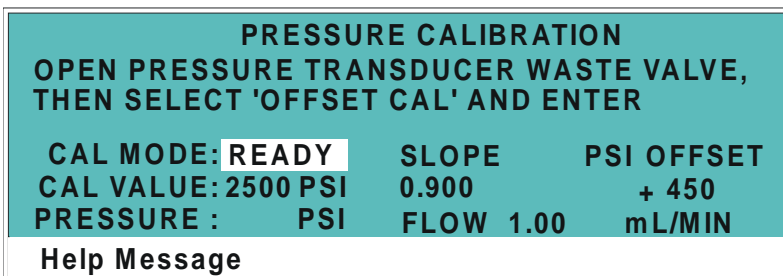

Figure C-25. Pressure Calibration Screen: Initial View

CAL MODE	Selects the calibration mode.
READY	The pump is ready for calibration.
OFFSET CAL	Calibrate the offset.
SLOPE CAL	Calibrate the slope.
SLOPE DFLT	Use the default slope value.
EDIT	Enter SLOPE and OFFSET values directly, without performing the calibration.
CAL VALUE	Pressure value entered during the slope calibration procedure.
PRESSURE	Current pressure reading from the transducer.
SLOPE	Calibrated slope value.
PSI [MPa] OFFSET	Calibrated offset value.
FLOW	Current flow rate.

Calibrating the Pump Pressure Offset

1. Stop the pump flow.
2. Go to the **PRESSURE CALIBRATION** screen.
3. Open the pressure transducer waste valve by turning it counterclockwise two turns (see Figure B-5).

4. When the pressure reaches zero, select **OFFSET CAL** and press **Enter**. The offset calibration begins. When calibration is complete, the screen displays the following:

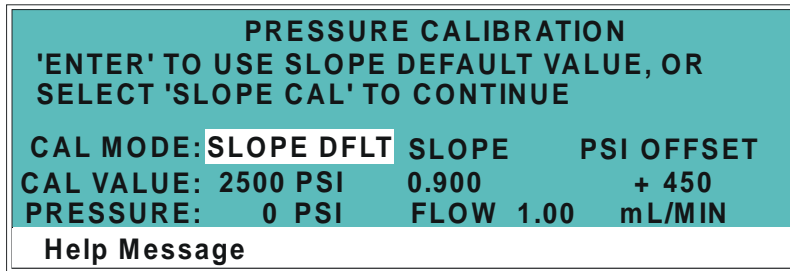

Figure C-26. Pressure Calibration Screen: Second View

The **PSI OFFSET** field displays the calibrated value. The **SLOPE** field does not change, and the **PRESSURE** field displays the new pressure based on the calibrated offset.

5. There are three choices for continuing:

- Save the PSI offset calibration and maintain the current slope value.

To implement: Press **Menu** to exit the **PRESSURE CALIBRATION** screen. The new offset value will take effect.

- Save the PSI offset calibration and save the default slope value displayed in the **SLOPE** field.

To implement: Press **Enter** to save the default slope value. The **PRESSURE** field displays the new pressure based on the calibrated offset and the default slope.

- Save the PSI offset calibration and calibrate the slope.

To implement: Press a **Select** button to select **SLOPE CAL** in the **CAL MODE** field and press **Enter**. Continue to the next section, “Calibrating the Slope.”

Calibrating the Slope

After selecting **SLOPE CAL** in Step 5, the screen displays the following:

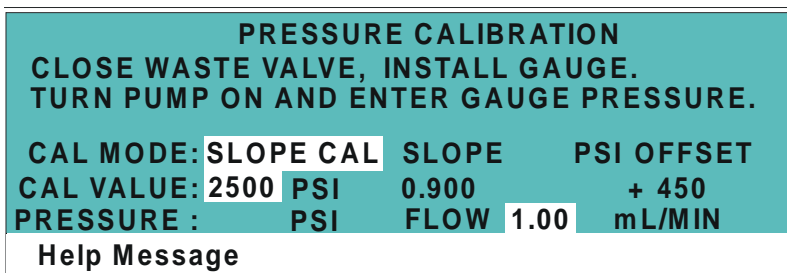

Figure C-27. Pressure Calibration Screen: Third View

1. Close the waste valve.
2. Install a pressure test gauge between the pressure transducer outlet and one of the following: backpressure tubing or a separator column (see Figure C-28). The pressure gauge assembly (P/N 046175) includes a gauge, backpressure tubing, and required fittings.

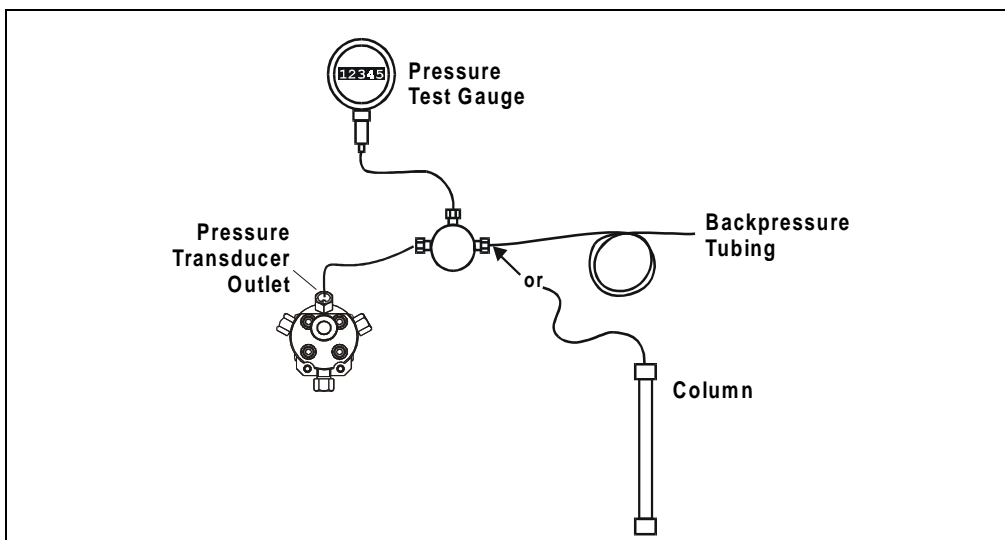

Figure C-28. Pressure Gauge Installation

3. In the **FLOW** field, enter the flow rate normally used for your application.
4. Turn on the pump. The pressure will begin increasing. Allow the pressure gauge reading to stabilize.
5. **Backpressure tubing**
 - If backpressure tubing is installed, the recommended pressure to use for calibration is 17.25 ± 0.17 MPa (2500 ± 25 psi). Add additional backpressure tubing or adjust the flow rate to achieve this backpressure. Increasing the flow rate increases the pressure; decreasing it decreases the pressure. When the gauge reading has stabilized at the recommended value, enter the reading in the **CAL VALUE** field.

Column

- If a column is installed, the pressure to use for calibration is determined by the application flow rate and the type of column installed. After allowing the pressure to stabilize, enter the reading in the **CAL VALUE** field.

NOTE The pressure gauge readings may fluctuate slightly as the left and right pump heads alternate piston strokes. You can ignore variations of about ± 0.03 MPa (± 5 psi) or less. Larger fluctuations generally indicate that the pump is out of prime. If this occurs, prime the pump heads (see Section B.2.8) and then repeat Step 5.

6. Press **Enter**. The slope calibration begins. When calibration is complete, the screen fields display the following:
 - The **SLOPE** field displays the new slope value.
 - The **PRESSURE** field displays the same value as the **CAL VALUE**.

C.3.7 Degas Pump Calibration

Use the **DEGAS PUMP CALIBRATION** screen to calibrate the degas pump.

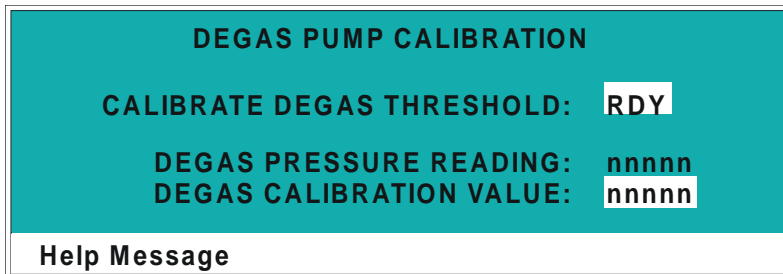

Figure C-29. Degas Pump Calibration Screen

CALIBRATE DEGAS THRESHOLD	To calibrate, select CAL and press Enter . After calibration is complete, the entry reverts to RDY .
DEGAS PRESSURE READING	Reports the current degas pressure reading.
DEGAS CALIBRATION VALUE	Reports the calibration value recorded during the last calibration.

D • TTL and Relay Control

The strip of eight 2-pin connectors on the GP50 electronics chassis provides two relay outputs, two TTL outputs, and four TTL inputs (see Figure D-1).

- To control functions in another device, connect the GP50 TTL or relay outputs to the TTL or relay inputs of the device to be controlled. See Section D.1 for details about GP50 TTL and relay output operation.
- To have another device control GP50 functions, connect the GP50 TTL inputs to the TTL outputs of the controlling device. The following functions can be controlled: pump motor on/off, method clock on/off, method number increment, and method number decrement. See Section D.2 for details about GP50 TTL input operation.

NOTE You can connect a non-Dionex device to the GP50, provided it is compatible with the GP50 TTL and relay signals. Refer to the user's manual for the device.

Refer to Section D.3 for connection instructions and examples.

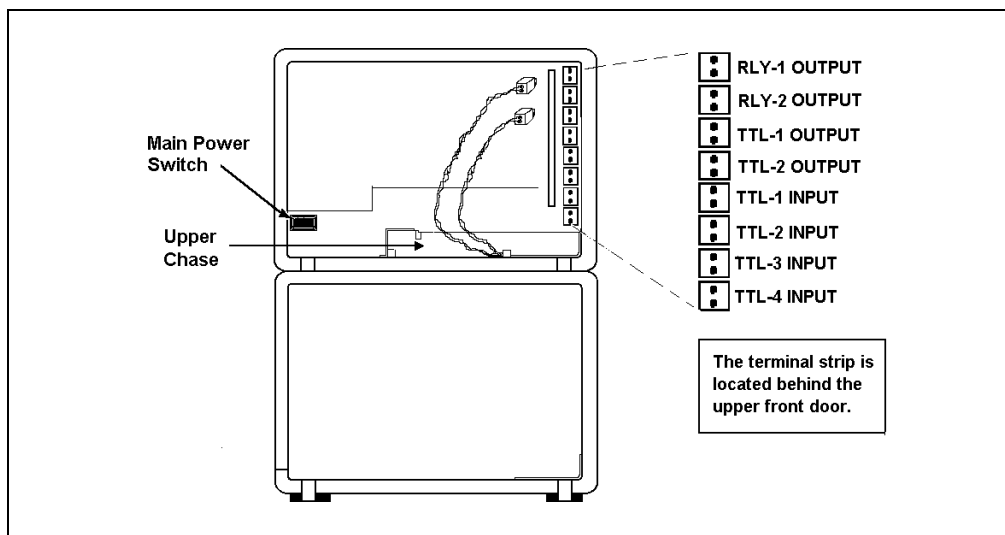

*Figure D-1. TTL Connector Strip
(GP50 front view without upper door)*

D.1 TTL and Relay Output Operation

The GP50 provides two TTL outputs and two relay contacts for controlling functions in external devices such as an integrator, autosampler, or another Dionex instrument.

After connecting the TTL and Relay outputs (see Section D.3), toggle the output states on and off from the **DETAIL** screen (see Section C.1.3) for Direct control, or program the output states from the **METHOD** extension screen (see Section C.1.5) for Method control.

- To turn on a TTL or relay output, set the corresponding output field in the **DETAIL** screen or **METHOD** extension screen to **1** (closed).
- To turn off a TTL or relay output, set the corresponding output field to **0** (open).

For example, if TTL2 is connected to the Load relay on the AS40 Autosampler, setting **TTL2** to 1, as shown in Figure D-2, sends the signal to the AS40 to start the load cycle.

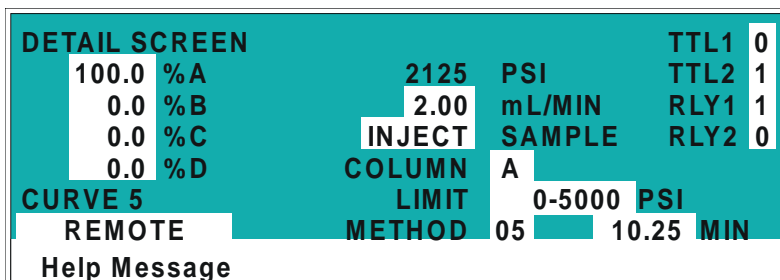

Figure D-2. Detail Screen

NOTE If the GP50 is connected to a PeakNet workstation, PeakNet software can control the TTL and Relay outputs. See the PeakNet online Help or user’s guide for details.

D.2 TTL Input Operation

The four TTL inputs can be connected to devices capable of providing TTL output signals. Each TTL input controls a specific function in the GP50. A signal from the connected device triggers the function associated with that input.

- **TTL input 1** turns the pump motor off and on.
- **TTL input 2** controls the pump method clock. A signal from the controlling device can turn the method clock on (Run) or off (Hold/Reset). Hold/Reset resets the method clock to zero and executes **INIT** conditions. The method will not run unless the pump motor is already on.
- **TTL input 3** increases the method number by one. Each additional signal increases the method number by one more.

When the method clock is zero (or **INIT**), increasing the method number executes the **INIT** conditions of the new method. When the method clock is greater than zero, increasing the method number begins running the new method at the current elapsed method clock time. This has the same result as selecting a new method number when the pump is in Local mode.

- **TTL input 4** decreases the method number by one. The operation is as described under TTL input 3 above, except that the method number decreases.

D.2.1 TTL Input Signal Modes

The GP50 TTL inputs respond to four different types of device output signals. The default signal mode, normal edge, is compatible with the output signals provided by Dionex modules. If the device connected to the GP50 outputs a different signal type, select the appropriate signal mode from the **TIME FUNCTION IN** screen (see Figure D-3).

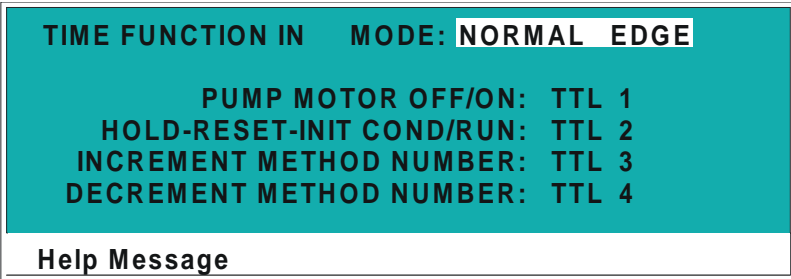

Figure D-3. Time Function In Screen

The four input signal modes are:

- *Normal Edge*: In normal edge operation, the negative (falling) edge of a signal turns on the function and the positive (rising) edge turns off the function (see Figure D-4). For example, a negative edge sent to TTL1 turns on the pump motor and a positive edge turns off the motor.
- *Inverted Edge*: The inverted edge mode works identically to the normal edge mode except that the positive and negative edges are reversed in function.
- *Normal Pulse*: In normal pulse operation, the negative (falling) edge of the TTL signal is the active edge and the positive (rising) edge is ignored. For example, applying a negative pulse to TTL1 when the pump motor is off turns the motor on. This has the same result as pressing the **Off/On** button on the front panel keypad.

The minimum pulse width guaranteed to be detected is 50 ms. The maximum pulse width guaranteed to be ignored as noise or invalid is 4 milliseconds. The action of the GP50 is undefined for pulses less than 50 ms or greater than 4 ms.

- *Inverted Pulse*: The inverted pulse mode operates identically to the normal pulse mode except that the positive and negative edges are reversed in function.

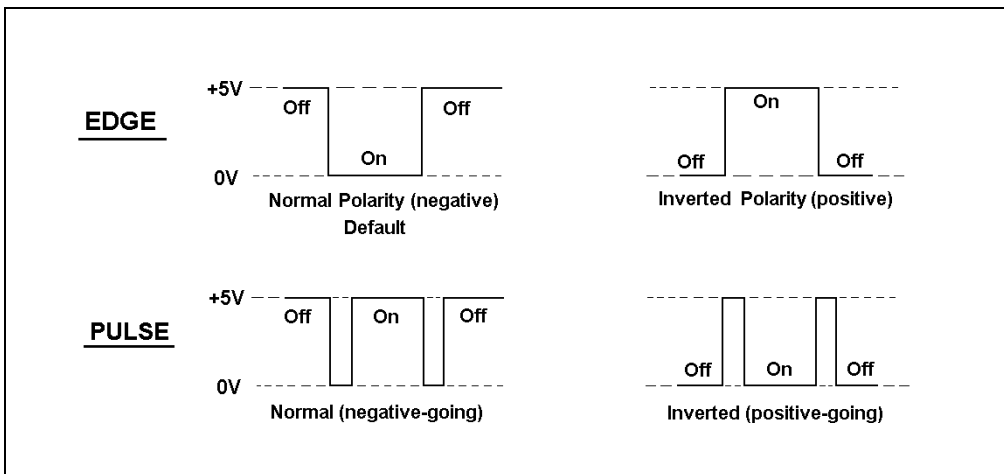

Figure D-4. TTL and Relay Input Signal Modes

D.3 TTL and Relay Connections

The TTL/relay connector strip is located on the electronics chassis behind the upper door (see Figure D-1). Each 2-pin connector includes a signal pin and a ground pin.

1. Locate the twisted pairs of wires (P/N 043598) and two-pin connector plugs (P/N 921019) provided in the GP50 Ship Kit. Attach a two-pin plug to each end of the twisted pair of wires to be connected. The signal wire goes on top and the ground wire goes on the bottom of each plug.
2. Connect these plugs to the TTL or relay connectors on the GP50 and the other instruments(s) as needed for your application. Check the polarity of each connection. Be sure to connect signal wires to signal (+) pins and ground wires to ground (-) pins. If necessary, remove wires from the two-pin plugs and reinsert them in the correct positions. Section D.3.1 shows example connections.
3. Route the wires from the GP50 electronics chassis through the upper chase (see Figure B-1) to the rear panel.

D.3.1 Example Connections

Figure D-5 shows an example of TTL/relay connections for a Dionex system connected to an AS40 Automated Sampler. Refer to the AS40 operator's manual for details.

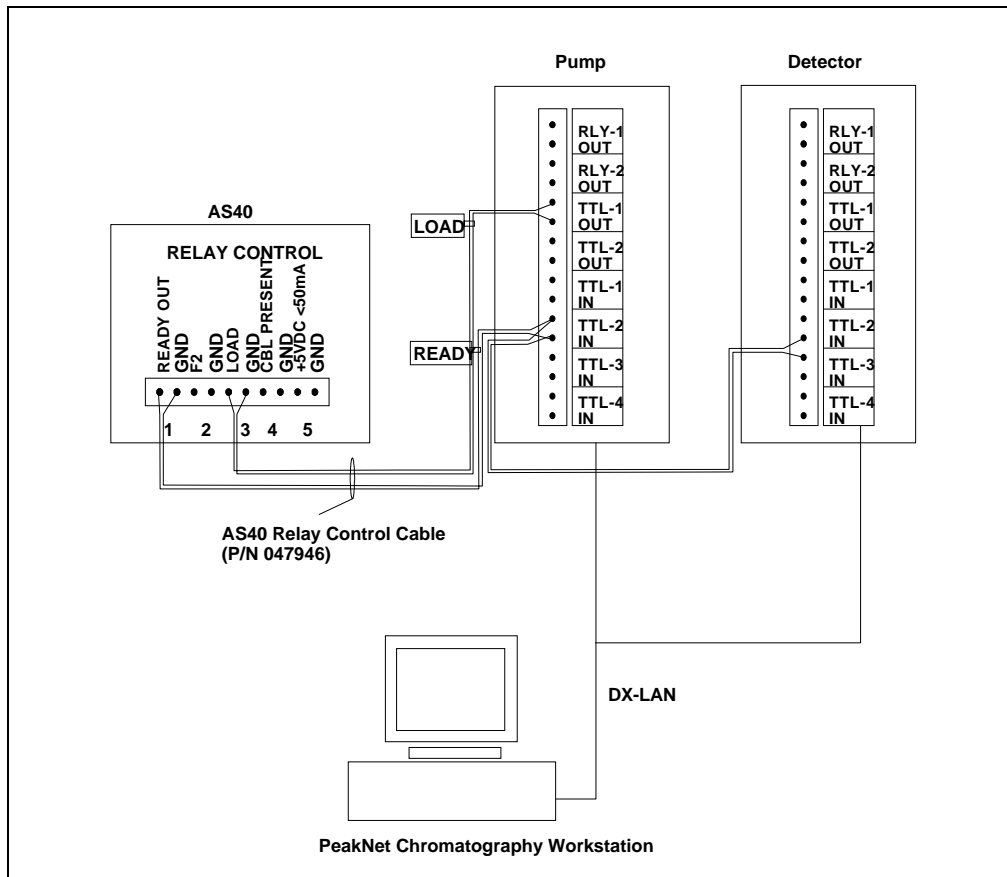

Figure D-5. Example TTL and Relay Connections: AS40

Figures D-6 and D-7 show two different TTL/relay connections for a Dionex system connected to an AS3500 Autosampler:

- Setup 1, recommended for isocratic conditions, starts running each Dionex module timed events method when the autosampler makes an injection.
- Setup 2, recommended for gradient conditions, starts running each Dionex module method before the autosampler makes an injection. The method then controls when the autosampler injection occurs.

Refer to the AS3500 manual for details.

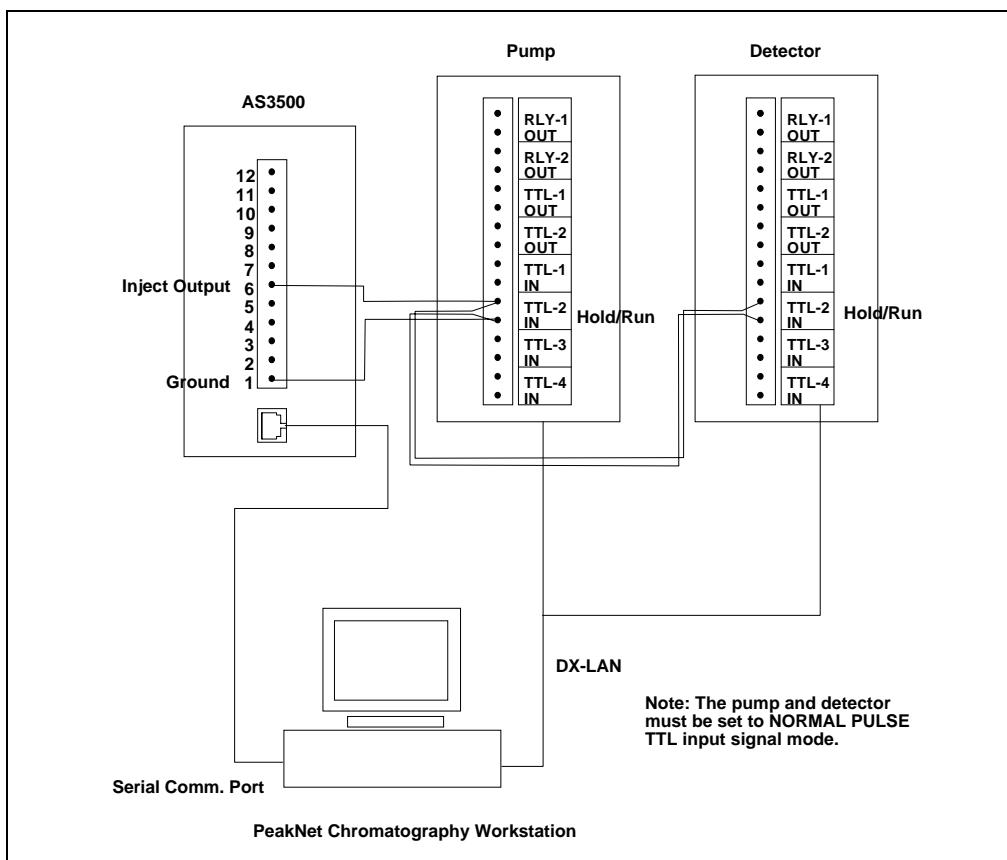

Figure D-6. Example TTL and Relay Connections:
AS3500 Setup 1

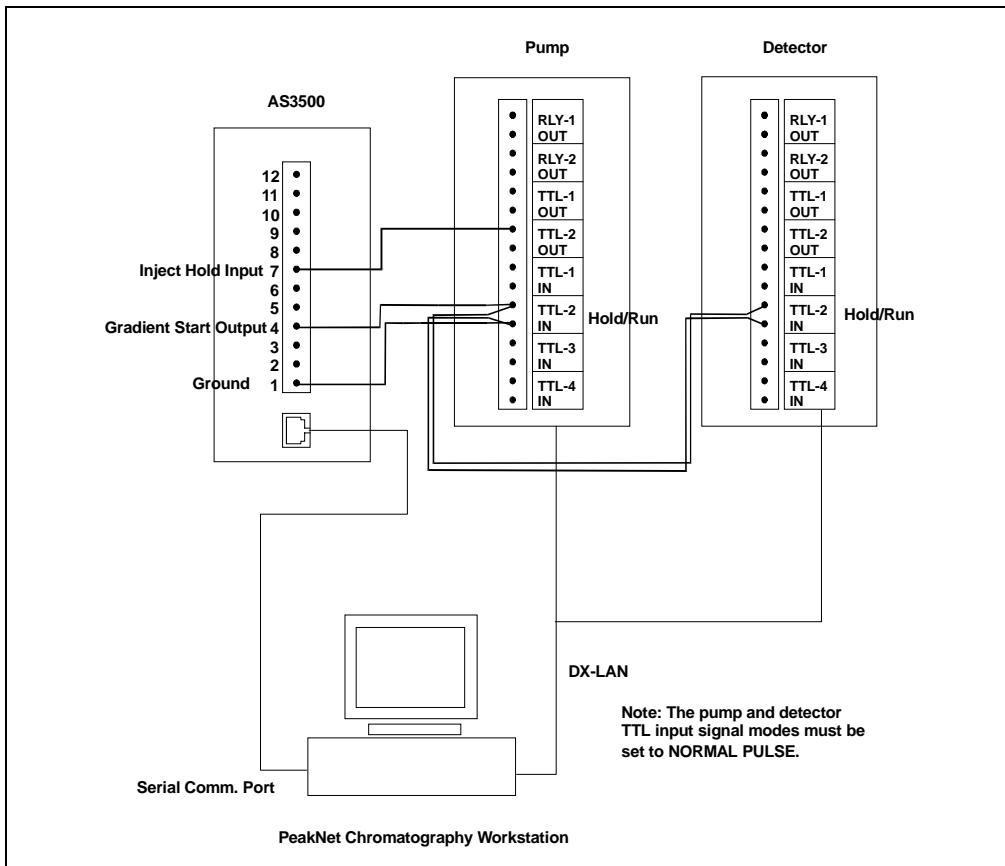

Figure D-7. Example TTL and Relay Connections:
AS3500 Setup 2

Symbols

- %A, %B, %C, %D, C-3, C-7
 - Entering eluent percentages, 3-7

Numerics

- 100 μ L pump heads, 2-14, C-12
- 10BASE-T DX-LAN cable
 - Installation, B-8
- 10BASE-T DX-LAN interface, 1-1
 - Installation, B-6 – B-9
 - Rear panel connector, 2-18
- 25 μ L pump heads, 2-14, C-12
- 60-pin ribbon cable, 2-10

A

- Aborting a running method, 3-12
- Activating error sounds, C-11
- Activating key press sounds, C-11
- Actuator for main power switch, 2-2
- Air pressure requirements, 3-2
- Air solenoid valves, 2-10
- Alarm, leak, 4-7
- Arrow buttons, 2-6
- AS3500 Autosampler, D-7
- AS40 Automated Sampler, D-6
- Automated control of GP50, 1-1, 2-18

B

- Backlight, 2-2, C-11
 - Adjusting brightness, C-11
 - Time in use, C-16
- BAR, C-12
- Battery, disposing, 5-1

- Binary curve gradients, 3-19
- Blank fields in method step, 3-8
- Blank screen, 2-2, C-11
- BNC DX-LAN interface, 1-1
 - Installation, B-9, B-11 – B-12
 - Rear panel connector, 2-18
- BNC tee connector installation, B-11
- Bottles
 - See* Reservoirs
- Button descriptions, 2-4 – 2-6

C

- C (curve) column in Method screen, 3-7, C-7
- Cables
 - 10BASE-T DX-LAN, B-6, B-8
 - 60-pin ribbon, 2-10
 - Air solenoid valves, 2-10
 - Coaxial DX-LAN, B-9, B-11
 - Front panel (60-pin ribbon cable), 2-10
 - LC10/LC20 leak sensor, 2-9, B-4
 - LC10/LC20/LC25/LC30 solenoid valves,
 - B-5
 - LC30 serial interface, 2-9, B-5
 - Power cord, B-3
- Calibration Menu, C-25
 - Calibration Status, C-26
 - Degas Pump Calibration, C-34
 - Degas Status, C-28
 - Flow Calibration, C-29
 - Leak Sensor Calibration and Status, C-27
 - Pressure Calibration, C-30
 - See also* Diagnostic screens
- Calibration procedures
 - Degas pump, C-34
 - Flow rate, C-29
 - Leak sensor, C-27
 - Pressure offset and slope, C-30 – C-33

Cards

See Printed circuit boards

Cascading hubs, B-9

CE Mark, 1-4

Check valves, 3-2

Cartridges, 5-3

Cause of pressure fluctuations, 4-2

Cleaning, 5-1

Description, 2-15

Replacing, 5-1 – 5-3

Chromatography software, 1-1

PeakNet 5, 2-18 – 2-19

PeakNet 6, 2-18 – 2-19

See also PeakNet 5 software and PeakNet 6 software

Circuit boards

See Printed circuit boards

Clock

See Method clock

Coaxial DX-LAN cable

Installation, B-11 – B-12

COL (A,B) field in Method screen, C-8

Column switching valve

Selecting, C-3, C-8

Computer control, 1-1, 2-18

See also Chromatography software

See also PeakNet 5 software and PeakNet 6 software

Concave linear curve, 2-23

Connectors

Electronics chassis, 2-8

LC Air valves, 2-10

LC Leak, 2-9

LC30 Communication, 2-9, B-5

TTL/Relay control, 2-10, D-1

Contacting Dionex, 4-1

Contamination, 3-2

Contrast, 2-2

Control modes, 2-18

Direct, 2-18

Flow, C-12

Method, 2-20 – 2-21

Pressure, C-12

Selecting, C-4

Specification, A-3

Summary, 2-19

Control panel, 2-2

Keypad, 2-3

Convex gradient curves, 2-23

CPU card, 2-10

Disposing of lithium battery, 5-1

Troubleshooting, 4-6

Creating a method, 3-8 – 3-9

Examples, 3-13

Cursor buttons, 2-6

Cursor movement, 2-6

Curve field

Detail screen, C-5

Curve types, 2-23

Curved gradient example, 3-19

Curves

See Gradient curves

D

Daily maintenance, 3-25

Degas Options screen, C-9

Degas pump assembly, 1-1, 2-16

Calibration, C-34

Calibration fails, 4-10

Description, 2-16

Flow schematic, 2-13

Flushing, 4-12, B-17, B-19

Low vacuum, 4-11

Selecting operating cycles, C-9

Specifications, A-3

Testing, 4-1, C-28

Troubleshooting, 4-9

Degas Pump Calibration screen, C-34

Degas Status screen, C-28

Degassing eluents, 2-17, 3-1, B-1

Manual procedure, 3-1

Troubleshooting, 4-1

Delay volume, A-2

Delete button, 2-5

Deleting

Field entries, 2-5

- Method steps, 2-5
 - Methods, 3-12
 - Description
 - Calibration screens, C-25
 - Diagnostic screens, C-14
 - Functional, 2-18
 - Physical, 2-1
 - TTL input control, D-3
 - User interface screens, C-2
 - See also* Physical description
 - Detail status screen, C-5
 - Diagnostic screens, C-14
 - Accessing, 2-6
 - Degas Status, C-28
 - Diagnostic Test, C-21
 - DSP Code Version, C-24
 - DSP Status, C-17
 - DX-LAN Status, C-18
 - Elapsed Time, C-16
 - Keyboard Test, C-20
 - Leak Status, C-27
 - Power-Up screen, C-15
 - Pressure Calibration, C-30
 - See also* Calibration Menu
 - Diagnostic Test screen, C-21
 - Digital Signal Processor (DSP), 1-1, C-17
 - See also* DSP
 - Dimensions, A-1
 - Dionex, Contacting, 4-1
 - Direct control mode, 3-6
 - Description, 2-18
 - Selecting, 3-5
 - Display and keypad specifications, A-1
 - Display screens, 2-7
 - Backlight, 2-2, C-11
 - Calibration Status, C-26
 - Degas Pump Calibration, C-34
 - Degas Status, C-28
 - Detail Status, C-5
 - Diagnostic screens, C-14, C-25
 - Diagnostic Test, C-21
 - DSP Code Version, C-24
 - DSP Status screen, C-17
 - DX-LAN Status, C-18
 - Elapsed Time, C-16
 - Leak Status, C-27
 - Main status, C-3
 - Menu of Screens, C-2
 - Method edit, C-6
 - Method edit extension screen, C-8
 - Module Setup screen, C-11
 - Power-Up, 2-7, 3-3, C-15
 - Pressure Calibration, C-30
 - Pump Options, C-12
 - Time Function In, C-13
 - Distribution card, 4-3, 4-9 – 4-10
 - Accessing, 5-11
 - DSP card, 2-9
 - Troubleshooting, 4-5 – 4-6, 4-8
 - DSP program, 1-1, 2-15
 - Error messages, 4-5 – 4-6
 - Status, C-17
 - Testing, C-22
 - DSP Status screen, 4-4, C-17
 - DX-LAN 10BASE-T cable
 - See* 10BASE-T DX-LAN cable
 - DX-LAN coaxial cable
 - See* Coaxial DX-LAN cable
 - DX-LAN interface, 1-1, 2-10, 2-18, 2-20, A-3
 - 10BASE-T connections, B-6
 - BNC connections, B-9
 - Card description, 2-10
 - Diagnostic test, C-22
 - Rear panel connector, 2-18
 - DX-LAN Status screen, C-18
- ## E
- E01 Eluent Organizer, 2-17
 - Editing a method, 3-11
 - Editing a running method, 3-23
 - Elapsed Time screen, C-16
 - Electrical specifications, A-1
 - Electronics cards
 - See* Printed circuit boards

- Electronics chassis, 2-8
 - Connections, B-4
 - CPU, 2-10
 - LC leak, 2-9, B-4
 - LC30 communications, B-5
 - TTL/Relay, 2-10
 - TTL/Relay connections, D-5
- Eluent manifold, 2-13
 - Flushing, 3-27
- Eluent reservoirs
 - See* Reservoirs
- Eluents
 - Composition profile for gradient curves, 2-22
 - Connecting lines to pump, B-14
 - Degassing, 2-16, 3-1, 4-1
 - Filtering, 3-2, 4-1
 - Flow schematic, 2-13, 3-26
 - Flushing lines after changing, 4-12
 - Gradient delivery of, 2-22
 - Isocratic delivery of, 2-22
 - Method control of eluent mixture, 2-20
 - Outlet line connections, B-14
 - Pressuring reservoirs, B-1
 - Preventing crystallization, 3-25
 - Pump mixers, 2-14
 - Specifying composition, 3-6 – 3-7, C-3, C-7
 - Specifying flow rate, C-3, C-7
 - Waste line, B-13
- End-line filter, 3-2, B-1
- English
 - On-screen messages, C-11
- Enter button, 2-6
- Entry error sounds, C-11
- Environmental specifications, A-1
- Error messages
 - Encoder index not found, 4-6
 - High pressure limit violation, 4-5
 - Language selection, C-11
 - Low pressure limit violation, 4-4
 - Motor drive fails, 4-6
 - TTL2 is set to indicate FLOW/NO FLOW, 4-11

- Vacuum degas fails, 4-10
- Example methods, 3-13 – 3-24
- External leak sensor, C-27

F

- Facilities required, B-1
- Filter, end-line, 3-1 – 3-2, B-1
 - Dirty or clogged, 4-1
- Filtered inert gas, 3-1 – 3-2
- Fittings
 - Leaking, 3-26
- Flow Calibration screen, C-29
- Flow column, in Method screen, 3-7
- Flow mode, C-12
- Flow rate
 - Calibrating, C-29
 - Calibration Status screen, C-26
 - Ranges, 2-14, A-2
 - Selecting, C-3
 - Setting in Method screen, 3-7, C-7
 - Stabilizing, 3-7
- Flow schematic, 2-13
- Front panel, 2-2
 - Display screens, 2-7
 - Keypad, 2-3
 - Tilting, 2-2
- Front panel buttons
 - Description, 2-4 – 2-6
- Functional description, 2-18
 - Method control, 2-20
- Fuses, A-1
 - Replacing, 5-13

G

- Gas regulator, 3-2
- Generating a method, 3-8
- GM-4 Gradient Mixer, 2-14
- GM-5 Gradient Mixer, 2-14
- Gradient control specifications, A-3

- Gradient curves, 2-22
 - Concave, 2-23
 - Convex, 2-23
 - Linear, 2-23
- Gradient eluent run, 2-22
 - Curved gradient example, 3-19
 - Linear gradient example, 3-14

H

- Heads
 - See* Pump heads
- Helium, 3-2
- Help messages
 - Language selection, C-11
- Hold/Run
 - Front panel button, 2-5
- Host computer, 1-1, 2-18, 2-20
 - Connecting, B-6, B-9
- Hub, 10BASE-T, B-6, B-8 – B-9
- Humidity, A-1
- Hydraulic specifications, A-2

I

- Important icon, 1-3
- INIT (initial conditions), 2-5, 3-9
- Injection valve
 - Connection, B-4
 - Controlling position of, C-3
- Inlet line connection, B-14
- Insert button, 2-4
- Inserting Method steps, 2-4
- Installation, B-1
 - 10BASE-T DX-LAN interface, B-6
 - BNC DX-LAN interface, B-9
 - CPU, 2-10
 - Eluent line connections to pump, B-14
 - Eluent outlet line, B-14
 - Eluent reservoirs, 2-17
 - Facilities required, B-1
 - LC air valves, B-5

- LC leak, 2-9, B-5
 - LC10/LC20 connections, B-4
 - LC25 connections, B-5
 - LC30 connections, B-5
 - Power connection, B-2
 - Priming the manifold, B-17
 - Pump interface card, B-6 – B-7, B-9 – B-10
 - Rear panel, 2-18
 - Setting pressure limits, 3-4
 - TTL/Relay connections, 2-10, D-5
 - Waste line, B-13
- Internal leak sensor, C-27
 - Introduction, 1-1
 - Inverted edge, D-4
 - Inverted pulse, D-4
 - Isocratic eluent run, 2-22, 3-13

J

- Japanese
 - On-screen messages, C-11

K

- Key press sound, C-11
- Keyboard Test screen, C-20
- Keypad, 2-3 – 2-6
- Keypad buttons, 2-3
 - Delete, 2-5
 - Enter, 2-6
 - Key press sound, C-11
 - Menu, 2-6
 - Numerical keys, 2-6
 - Off/On, 2-4
 - Prime, 2-4
 - Reset, 2-5
 - Select, 2-5

L

- LC leak, 2-9, B-5
- LC10 Chromatography Organizer
 - Connections to pump, B-4
 - Leak control cable, 2-9
 - Solenoid valve connections, 2-10
- LC20 Chromatography Enclosure
 - Connections to pump, B-4
 - Leak control cable, 2-9
 - Solenoid valve connections, 2-10
- LC25 Chromatography Oven
 - Built-in eluent containment, B-1
 - Connections to pump, B-5
 - Solenoid valve connections, 2-10
- LC30 Chromatography Oven
 - Connections to pump, 2-9, B-5
 - Solenoid valve connections, 2-10
- Leak alarm, 4-6 – 4-7
- Leak sensor
 - Calibration, C-27
 - Status, C-27
 - Testing, C-22
- Leak sensor cable (LC10/LC20), 2-9
- Leak status screen, C-27
- Leaks
 - Checking for, 3-26
 - Mechanical chassis, 4-8
 - Piston seals, 4-12
 - Pressure transducer, 4-7
 - Priming valve, 4-7
 - Proportioning valve, 4-7
 - Pump heads, 4-7
 - Rinse ports, 4-7
 - Troubleshooting, 4-2, 4-4, 4-7 – 4-8
- LED
 - Power supply status, 2-10
- Left/right pressurization points, C-23
- Limit field
 - Detail screen, C-5
 - Method screen, C-6
- Linear gradient curve, 2-23
- Linear gradient example, 3-14
- Liquid crystal display (LCD)

- Adjusting the screen contrast, 2-2
- Liquid leaks
 - See* Leaks
- Liquid lines
 - PEEK, 5-2
 - Stainless steel, 5-2
- Local mode, 2-19
 - Commands allowed, 2-19
 - Description, 2-18
 - Selecting, 2-18, 2-20, 3-5
- Locked Remote mode, 2-19 – 2-20, C-4
 - Description, 2-18
 - Selecting, 3-5, C-4

M

- Main status screen, C-3
- Maintenance, 3-25
 - Daily, 3-25
 - Periodic, 3-27
 - Replacing piston seals, 3-27
 - Routine maintenance, 3-25
- Manifold, 2-13
- Menu
 - Accessing, 2-6
 - Selecting options, 2-6
- Menu button, 2-6
- Menu of Screens, C-2
- Menu structure chart, C-1
- Method clock, 2-21
 - Controlling, 3-12
 - Controlling with TTL input, D-3
 - Starting, 2-5
 - Starting a method, 3-10
 - Stopping, 2-5
- Method control, 2-21, 3-7
 - Description, 2-19
 - Selecting, 3-5
- Method edit extension screen, C-8
- Method edit screen, C-6
- Method number, C-4

Method steps

- Adding, 2-4
- Blank fields in, 2-5, 3-8
- Definition, 2-21
- Deleting, 2-5
- Entering, 3-7, C-6
- Inserting, 3-9
- Maximum number allowed, 2-21
- Restoring the previous value, 2-5
- Setting step times, C-6

Methods

- Aborting a running method, 3-12
- Control, 3-7
- Creating, 3-8
- Curved gradient example, 3-19
- Deleting a method, 3-12
- Deleting a step, 3-11
- Editing, 3-11, 3-23
- Examples, 3-13 – 3-24
- Gradient curve types, 2-23
- Gradient eluent run, 2-22
- INIT conditions, 3-9
- Isocratic eluent run, 2-22, 3-13
- Linear gradient example, 3-14
- Number allowed, 2-21
- Running a method, 3-10

Microbore heads, 2-14

See also Pump heads

MIN, C-4

Mixers, 2-14

mL/MIN, C-3

Modes of operation

See Operating modes

Module Setup screen, C-11

Moduleware, 2-10

MPa, C-12

N

- Normal edge, D-4
- Normal pulse, D-4
- Numeric buttons, 2-6

O

- Off/On button, 2-4
- Offset calibration, C-30
- Operating configuration
 - TTL, D-3
- Operating mode, 2-18
 - Direct control, 2-18, 3-6
 - Local mode, 2-18 – 2-19, 3-6 – 3-7
 - Locked Remote mode, 2-18, 2-20
 - Method control, 2-19 – 2-20, 3-7
 - Remote mode, 2-18, 2-20
 - Selecting, C-4
 - Selecting the modes, 3-5
- Operation, 3-1
 - Aborting a running method, 3-12
 - Creating a method, 3-8
 - Curved gradient example, 3-19
 - Deleting a method, 3-12
 - Editing a method, 3-11
 - Editing a running method, 3-23
 - Gradient curve types, 2-23
 - Gradient eluent run, 2-22
 - INIT conditions, 3-9
 - Isocratic eluent run, 2-22, 3-13
 - Linear gradient example, 3-14
 - Method control, 3-7
 - Preparing to run, 3-1
 - Priming, B-17
 - Programming the pump, 3-13
 - Running a method, 3-10
 - Running the pump, 3-13
 - Selecting pressure limits, 3-4
 - Shutdown, 3-27
- Operational screens, 2-6, C-2
- Outlet line connection, B-14

P

- PeakNet 5 software, 2-18 – 2-19, C-4
 - Selecting Locked Remote mode, 2-20

GP50 Gradient Pump

- PeakNet 6 software, 2-18 – 2-19, C-4
 - Connect command, 2-20
 - Selecting Locked Remote mode, 2-20
- PEEK liquid lines, 5-2
- Periodic maintenance, 3-27
- Physical description
 - Control panel, 2-3
 - Display screens, 2-7
 - Mixers, 2-14
 - Pressure transducer, 2-15
 - Pump eluent manifold, 2-13
 - Pump heads, 2-14
 - Pump priming block, 2-15
 - Rear panel, 2-18
 - Vacuum degas pump assembly, 2-16
- Physical specifications, A-1
- Piston replacement, 5-8
- Piston seal replacement, 5-4
- Piston seal wash kit, 2-16
 - Installation procedure, B-15
- Piston volume, 2-14
- Power requirements, A-1
- Power supply, 2-10
- Power switches, 2-2
- Power-Up, C-15
- Power-Up screen, 2-7, 3-3
- Pressure
 - Maximum operating, 2-14
- Pressure Calibration screen, C-30
- Pressure limits, 3-4, C-6
- Pressure mode, C-12
- Pressure transducer, 2-15
 - Waste valve, 2-15, B-18
- Pressure units, C-12
- Pressurization points, C-23
- Pressurizing reservoirs, B-1
- Prime button, 2-4
- Priming, B-17
 - Eluent manifold, B-17
 - Problems during, 4-3
 - Pump out of prime, 4-1 – 4-2
 - With a syringe, B-17
 - With alcohol, B-19
 - With the Prime button, B-18
- Priming block, 2-15
- Priming valve
 - Leaks from, 4-7
- Printed circuit boards, 2-8
 - Connectors, 2-9
 - CPU card, 2-10, 4-6
 - Distribution card, 4-3, 4-9 – 4-10, 5-11
 - DSP card, 2-9, 4-5 – 4-6
 - DX-LAN pump interface card, 2-10, B-6, B-9
 - Host computer DX-LAN card, B-8
 - Relay I/O card, 2-10
- Programming the pump, 3-13
 - Gradient eluent run, 2-22
 - Isocratic eluent run, 2-22, 3-13
- Proportioning valve, 2-13, 2-17
 - Leaks, 4-7
 - Malfunction, 4-12
 - Replacement, 5-11 – 5-12
 - Testing, C-21
- PSI, C-3, C-12
- Pump configurations, 2-14
- Pump eluent manifold, 2-13
- Pump heads, 2-14
 - Assembly drawing, 5-5
 - Assembly part numbers, 5-5
 - Specifying material type, C-12
 - Specifying volume (25/100 μ L), C-12
- Pump interface card
 - Installation procedure, B-6 – B-7, B-9 – B-10
- Pump mixers, 2-14
- Pump motor control, 2-4
- Pump Options screen, B-20, C-12
- Pump priming block, 2-15
- Pump versions, 1-1

R

- Rear panel, 2-18, B-3
 - 10BASE-T DX-LAN interface, B-8
 - BNC DX-LAN interface, B-11
 - Fuses, 5-13
 - Power receptacle, B-3
 - Waste lines, B-13
- Regulator, 3-2
- Relay connectors, 2-10
 - See also* TTL/Relay control
- Remote mode, 2-19, C-4
 - Description, 2-18, 2-20
 - Locked Remote, 2-20
 - Selecting, 2-18, 3-5
- Reservoirs
 - Installation, B-1, B-14
 - Installation in EO1, 2-18, B-1
 - Pressurizing, 3-2
 - Storing eluents, 3-1
 - Types of, 2-17
- Reset button, 2-5
- Rinse ports, leaks from, 4-2, 4-7, 4-12, 5-4, 5-8
- Rinsing
 - Piston seals, 3-25, 3-27
 - Piston seals continuously, 2-16, 3-25, B-15
 - Pump components, 3-27
 - System continuously during shutdown, 3-27
- Routine maintenance, 3-25
 - Daily, 3-25
- Running methods, 2-5, 3-10
 - Editing while running, 3-23

S

- Safety labels, 1-4
- Safety messages, 1-3
- Salt crystals, 2-16, 3-25
- Save to field
 - Method screen, C-6
- Schematic, eluent flow, 2-13
- Screen brightness, C-11

- Screen contrast, 2-2
- Screens
 - See* Display screens
- Seal replacement, 5-4
- Select buttons, 2-5
- Self-Regenerating Suppressor (SRS)
 - Automatic power shutoff, 4-11, B-20 – B-21
- Service, 5-1
 - Check valves, 5-1
 - Fuses, 5-13
 - Piston seal, 5-4
 - Proportioning valve, 5-11
 - Pump piston, 5-8
 - Waste valve O-ring, 5-10
- Setting pressure limits, 3-4
- Setting step times, C-6
- Shutdown, 3-27
- Signal modes for TTL input, D-3
- Solenoid valves
 - Connecting to the LC10/20/25/30, 2-10, B-4
- Specifications
 - Control modes, A-3
 - Display and keypad, A-1
 - Electrical, A-1
 - Environmental, A-1
 - Hydraulic, A-2
 - Physical, A-1
 - Vacuum degas assembly, A-3
- SRS
 - See* Self-Regenerating Suppressor (SRS)
- Stabilizing the flow rate, 3-7
- Stainless steel liquid lines, 5-2
- Standard bore heads, 2-14
 - See also* Pump heads
- Starting methods, 2-5
- Step
 - See* Method steps
- Step gradient change, 3-17
- Stopping methods, 2-5
- System outlet line, B-14

T

- Technical support, 4-1
- Temperature, A-1
- Tests
 - Diagnostic, C-21
 - Keyboard, C-20
 - Pressure transducer, C-23
- Tilting the front panel, 2-2
- Time
 - Pump, seals, backlight in use, C-16
 - Setting the clock, 3-12
- Time field
 - Method screen, C-6
- Time Function In screen, C-13, D-3
- Time-based steps, entering, 3-7
- Transducer, 2-15
- Troubleshooting, 4-1
 - Chromatographic reproducibility, 4-12
 - Degas vacuum pump calibration, 4-10
 - Leak alarm, 4-6
 - Liquid leaks, 4-6
 - Noisy pump motor, 4-8
 - Pump head pressure fluctuations, 4-1
 - Pump out of prime, 4-1
 - Pump stops, 4-3
 - Pump will not start, 4-3
 - Relay control functions, 4-11
- TTL input operation, 2-19, 4-11
 - Functions controlled by, C-13, D-3
 - Signal modes, D-3 – D-4
- TTL/Relay control, D-1
 - Connections for SRS power control, B-20
 - Connectors, 2-10, D-1
 - Does not operate, 4-11
 - Example connections, D-6
 - Input operation, 2-19, D-3
 - Input signal modes, D-3
 - Installation, D-5
 - Output operation, D-2
 - Setting outputs, C-5, C-8, D-2
 - TTL input signal modes, D-4
 - TTL2 output does not operate, 4-11
- TTL2 output usage, B-20, C-12

- TUV, 1-4
- Type of control
 - See* Operating mode

U

- User interface, C-1
- User interface screens
 - See* Display screens

V

- V (valve) column in Method screen, 3-7, C-7
- Vacuum degas pump assembly
 - See* Degas pump assembly
- Valves
 - Check valves, 5-1
 - Column switching, C-3, C-8
 - Injection, C-3
 - Pressure transducer waste valve, 2-15, B-18
 - Proportioning, 2-13, 2-17, C-21
 - See also* Names of valves

W

- Waste lines
 - Installation, B-13
 - Piston seal wash, B-15
 - Pressure transducer, 2-15
- Waste valve, 2-15, B-18
- Weight, A-1